

AXOR Citterio M
2-Loch Einhebel-Küchenmischer mit Ausziehbrause
 Oberflächen: **Chrom** Artikelnummer: **34822000**

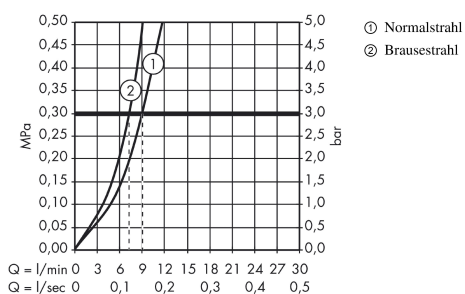

Durchflussdiagramm



AXOR Citterio M
2-Loch Einhebel-Küchenmischer mit Ausziehbrause
 Oberflächen: **Chrom** Artikelnummer: **34822000**



Explosionszeichnung

Baujahr: >10/17

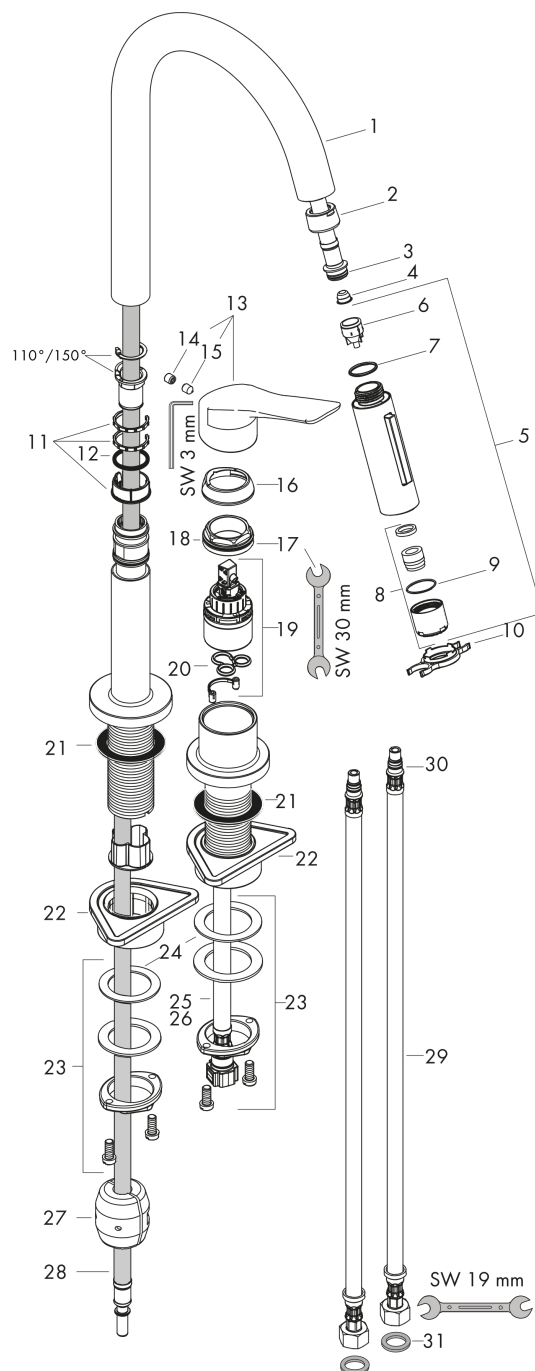

AXOR Citterio M
2-Loch Einhebel-Küchenmischer mit Ausziehbrause
 Oberflächen: **Chrom** Artikelnummer: **34822000**



Ersatzteilliste

Baujahr: >10/17

Pos.	Beschreibung	Artikelnummer	PG	VE
1	Auslauf kpl.	95562000	0	1
2	Mutter	92755000	0	1
3	O-Ring 11x2	98127000	0	1
4	Sieb	97735000	0	1
5	Ausziehbrause	95908000	0	1
6	Rückflußverhinderer	96737000	0	1
7	O-Ring 18x1,5	98231000	0	1
8	Strahlregler laminar M22x1 (15 l/min)	95909000	0	1
9	O-Ring 20x1	98140000	0	1
10	Serviceschlüssel	95910000	0	1
11	Gleitring-Set	98365000	0	1
12	O-Ring 21x2,5	98211000	0	1
13	Griff	95902000	0	1
14	Griffstopfen	96762000	0	1
15	Madenschraube M6x8	98444000	0	1
16	Kappe	96763000	0	1
17	Mutter	97209000	0	1
18	O-Ring 33x2	98154000	0	1
19	Kartusche kpl.	92730000	0	1
20	Dichtung	95008000	0	1
21	Zwischenlage	97825000	0	1
22	Befestigungsteil	97523000	0	1
23	Schaftbefestigung kpl. (Ø 34)	95049000	0	1
24	Gleitring	97548000	0	1
25	Anschlussschlauch 600 mm M10x1	95561000	0	1
26	O-Ring 8x1,75	97827000	0	1
27	Gewicht	98551000	0	1
28	Schlauch 1,50 m	95507000	0	1
29	Anschlussschlauch 900 mm M8x0,75 G3/8	96316000	0	1
30	O-Ring 7x1,5	98422000	0	1
31	Dichtungsset	95581000	0	1
a	Armaturenfett	90920000	0	1

DE / Gebrauchsanleitung / Montageanleitung	02
FR / Mode d'emploi / Instructions de montage	03
EN / Instructions for use / assembly instructions	04
IT / Istruzioni per l'uso / Istruzioni per Installazione	05
ES / Modo de empleo / Instrucciones de montaje	06
NL / Gebruiksaanwijzing / Handleiding	07
DK / Brugsanvisning / Monteringsvejledning	08
PT / Instruções para uso / Manual de Instalação	09
PL / Instrukcja obsługi / Instrukcja montażu	10
CS / Návod k použití / Montážní návod	11
SK / Návod na použitie / Montážny návod	12
ZH / 用户手册 / 组装说明	13
RU / Руководство пользователя / Инструкция по монтажу	14
HU / Használati útmutató / Szerelési útmutató	15
FI / Käyttöohje / Asennusohje	16
SV / Bruksanvisning / Monteringsanvisning	17
LT / Vartotojo instrukcija / Montavimo instrukcijos	18
HR / Upute za uporabu / Uputstva za instalaciju	19
TR / Kullanım kılavuzu / Montaj kılavuzu	20
RO / Manual de utilizare / Instrucțiuni de montare	21
EL / Οδηγίες χρήσης / Οδηγία συναρμολόγησης	22
SL / Navodilo za uporabo / Navodila za montažo	23
ET / Kasutusjuhend / Paigaldusjuhend	24
LV / Lietošanas pamācība / Montāžas instrukcija	25
SR / Uputstvo za upotrebu / Uputstvo za montažu	26
NO / Bruksanvisning / Montasjeveiledning	27
BG / Инструкция за употреба / Ръководство за монтаж	28
SQ / Udhëzuesi i përdorimit / Udhëzime rreth montimit	29
AR / دليل الاستخدام / تعليمات التجميع	30

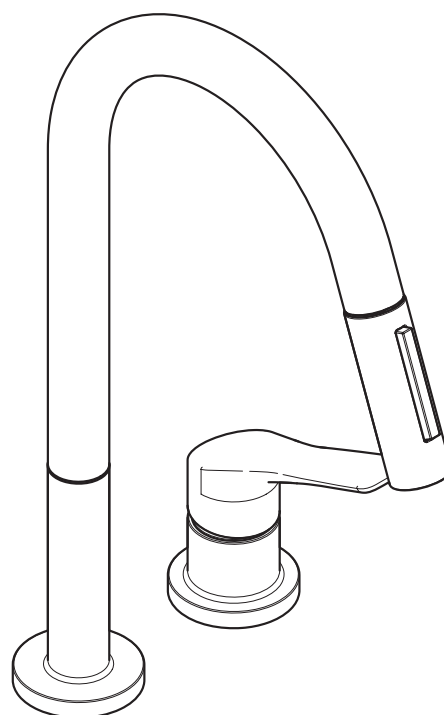

AXOR Citterio M
34822000 / 34822800

⚠ SICHERHEITSHINWEISE

- ⚠ Bei der Montage müssen zur Vermeidung von Quetsch- und Schnittverletzungen Handschuhe getragen werden.
- ⚠ Große Druckunterschiede zwischen den Kalt- und Warmwasseranschlüssen müssen ausgeglichen werden.

MONTAGEHINWEISE











- / Vor der Montage muss das Produkt auf Transportschäden untersucht werden. Nach dem Einbau werden keine Transport- oder Oberflächenschäden anerkannt.
- / Die Leitungen und die Armatur müssen nach den gültigen Normen montiert, gespült und geprüft werden.
- / Die in den Ländern jeweils gültigen Installationsrichtlinien sind einzuhalten.

TECHNISCHE DATEN

Betriebsdruck:	max. 1 MPa
Empfohlener Betriebsdruck:	0,1 - 0,5 MPa
Prüfdruck:	1,6 MPa (1 MPa = 10 bar = 147 PSI)
Heißwassertemperatur:	max. 70°C
Empfohlene Heißwassertemperatur:	65°C
Thermische Desinfektion:	max. 70°C / 4 min

Das Produkt ist ausschließlich für Trinkwasser konzipiert!

SYMBOLERKLÄRUNG

-  Kein essigsäurehaltiges Silikon verwenden!
-  **JUSTIERUNG** (siehe Seite 33)
Einstellen der Warmwasserbegrenzung. In Verbindung mit Durchlauferhitzern ist eine Warmwassersperre nicht zu empfehlen.
-  **BEDIENUNG** (siehe Seite 34)
 - / Hansgrohe empfiehlt, morgens oder nach längeren Stagnationszeiten den ersten halben Liter nicht als Trinkwasser zu verwenden.
 - / Auslauf nicht weiter drehen als 360°, da sonst der Schlauch beschädigt werden kann.
-  **REINIGUNG** (siehe Seite 37)
-  **WARTUNG** (siehe Seite 37)
Rückflussverhinderer müssen gemäß DIN EN 1717 regelmäßig in Übereinstimmung mit nationalen oder regionalen Bestimmungen auf ihre Funktion geprüft werden (mindestens einmal jährlich).
-  **MASSE** (siehe Seite 35)
-  **DURCHFLUSSDIAGRAMM** (siehe Seite 35)
 - ① Normalstrahl
 - ② Brausestrahl
-  **SERVICETEILE** (siehe Seite 36)
 - XXX = Farbcodierung
 - 000 = chrom
 - 800 = edelstahl-optik
- SONDERZUBEHÖR** (nicht im Lieferumfang enthalten)
-  Serviceschlüssel #95910000 (siehe Seite 36)
-  **PRÜFZEICHEN** (siehe Seite 36)

STÖRUNG	URSACHE	ABHILFE
/ Armatur schwergängig	/ Kartusche defekt, verkalkt	/ Kartusche austauschen
/ Armatur tropft	/ Kartusche defekt	/ Kartusche austauschen
/ Wasseraustritt am Befestigungsschaft	/ Anschlusschläuche nicht ganz in den Grundkörper eingeschraubt	/ Anschlusschläuche von Hand festziehen
	/ O-Ring am Anschlusschlauch defekt	/ O-Ring austauschen
/ Zu niedrige Warmwassertemperatur	/ Warmwasserbegrenzung falsch eingestellt	/ Warmwasserbegrenzung einstellen

⚠ CONSIGNES DE SÉCURITÉ

- ⚠ Lors du montage, porter des gants de protection pour éviter toute blessure par écrasement ou coupure.
- ⚠ Il est conseillé d'équilibrer les pressions de l'eau chaude et froide.

INSTRUCTIONS POUR LE MONTAGE











- / Avant son montage, s'assurer que le produit n'a subi aucun dommage pendant le transport. Après le montage, tout dommage de transport ou de surface ne pourra pas être reconnu.
- / Les conduites et la robinetterie doivent être montés, rincés et contrôlés selon les normes en vigueur.
- / Les directives d'installation en vigueur dans le pays concerné doivent être respectées.

INFORMATIONS TECHNIQUES

Pression de service autorisée:	max. 1 MPa
Pression de service conseillée:	0,1 - 0,5 MPa
Pression maximum de contrôle:	1,6 MPa (1 MPa = 10 bar = 147 PSI)
Température d'eau chaude:	max. 70°C
Température recommandée:	65°C
Désinfection thermique:	max. 70°C/4 min

Le produit est exclusivement conçu pour de l'eau potable!

DESCRIPTION DU SYMBOLE

-  Ne pas utiliser de silicone contenant de l'acide acétique!
-  **ETALONNAGE** (voir pages 33)
Réglage de la limitation d'eau chaude. En liaison avec les chauffe-eau, un blocage de l'eau chaude n'est pas recommandable.
-  **INSTRUCTIONS DE SERVICE** (voir pages 34)
/ Hansgrohe recommande de ne pas utiliser le premier demi-litre le matin ou après une période de stagnation prolongée.
/ Le bec ne peut être tourné à plus de 360° sinon le flexible risquerait d'être détérioré.
-  **NETTOYAGE** (voir pages 37)
-  **ENTRETIEN** (voir pages 37)
Les clapets anti-retour doivent être examinés régulièrement conformément à la norme EN 1717 ou conformément aux dispositions nationales ou régionales quant à leur fonction (au moins une fois par an).
-  **DIMENSIONS** (voir pages 35)
-  **DIAGRAMME DU DÉBIT** (voir pages 35)
① Jet de pluie
② Jet d'eau
-  **PIÈCES DÉTACHÉES** (voir pages 36)
XXX = Couleurs
000 = chromé
800 = aspect acier inox
- ACCESSOIRES EN OPTION** (ne fait pas partie de la fourniture)
 clé #95910000 (voir pages 36)
-  **CLASSIFICATION ACOUSTIQUE ET DÉBIT** (voir pages 36)

DYSFONCTIONNEMENT	ORIGINE	SOLUTION
/ Dureté de fonctionnement	/ Cartouche défectueuse, entartrée	/ Changer la cartouche
/ Le mitigeur goutte	/ Cartouche défectueuse	/ Changer la cartouche
/ Fuite à la fixation sous le mitigeur	/ Les flexibles de raccordement ne sont pas correctement visser dans le corps. / Joint torique sous les flexible de raccordements défectueux	/ Resserer le flexible à la main. / Changer le joint torique
/ Température d'eau chaude trop basse, pas d'eau froide	/ Limiteur de température mal positionné	/ Positionner le limiteur de température

⚠ SAFETY NOTES

- ⚠ Gloves should be worn during installation to prevent crushing and cutting injuries.
- ⚠ The hot and cold supplies must be of equal pressures.

INSTALLATION INSTRUCTIONS

- / Prior to installation, inspect the product for transport damages. After it has been installed, no transport or surface damage will be honoured.
- / The pipes and the fixture must be installed, flushed and tested as per the applicable standards.
- / The plumbing codes applicable in the respective countries must be observed.

TECHNICAL DATA

Operating pressure:	max. 1 MPa
Recommended operating pressure:	0,1 - 0,5 MPa
Test pressure:	1,6 MPa (1 MPa = 10 bar = 147 PSI)
Hot water temperature:	max. 70°C
Recommended hot water temp.:	65°C
Thermal disinfection:	max. 70°C/4 min

The product is exclusively designed for drinking water!

SYMBOL DESCRIPTION



Do not use silicone containing acetic acid!



ADJUSTMENT (see page 33)

To adjust the hot water limiter. Using a hot water limiter in combination with a continuous flow water heater is not recommended.



OPERATION (see page 34)

- / Hansgrohe recommends not to use as drinking water the first half liter of water drawn in the morning or after a prolonged period of non-use.
- / Do not rotate the spout further than 360° or damage to the hose will result.



CLEANING (see page 37)



MAINTENANCE (see page 37)

The check valves must be checked regularly according to DIN EN 1717 in accordance with national or regional regulations (at least once a year).



DIMENSIONS (see page 35)



FLOW DIAGRAM (see page 35)

- ① Normal spray
- ② Regular



SPARE PARTS (see page 36)

- XXX = Colors
- 000 = chrome plated
- 800 = stainless steel optic

SPECIAL ACCESSORIES (order as an extra)



service tool #95910000 (see page 36)



TEST CERTIFICATE (see page 36)

FAULT	CAUSE	REMEDY
/ Mixer stiff	/ Cartridge defective, calcified	/ Exchange cartridge
/ Mixer dripping	/ Cartridge defective	/ Exchange cartridge
/ Water escaping at the threaded base	/ connection hoses not completely screwed into basic body / O-ring at the connection hose defective.	/ Tighten connection hoses by hand / Exchange O-ring
/ Hot water temperature too low	/ Hot water limiter incorrectly set	/ Set hot water limiter

⚠ INDICAZIONI SULLA SICUREZZA

- ⚠ Durante il montaggio, per evitare ferite da schiacciamento e da taglio bisogna indossare guanti protettivi.
- ⚠ Attenzione! Compensare le differenze di pressione tra i collegamenti dell'acqua fredda e dell'acqua calda.

ISTRUZIONI PER IL MONTAGGIO











- / Prima del montaggio è necessario controllare che non ci siano stati danni durante il trasporto. Una volta eseguito il montaggio, non verranno riconosciuti eventuali danni di trasporto o delle superfici.
- / Montare, lavare e controllare tubature e rubinetteria rispettando le norme correnti.
- / Vanno rispettate le direttive di installazione nazionali vigenti nel rispettivo paese.

DATI TECNICI

Pressione d'uso:	max. 1 MPa
Pressione d'uso consigliata:	0,1 - 0,5 MPa
Pressione di prova:	1,6 MPa (1 MPa = 10 bar = 147 PSI)
Temperatura dell'acqua calda:	max. 70°C
Temp. dell'acqua calda consigliata:	65°C
Disinfezione termica:	max. 70°C / 4 min

Il prodotto è concepito esclusivamente per acqua potabile!

DESCRIZIONE SIMBOLO

-  Non utilizzare silicone contenente acido acetico!
-  **TARATURA** (vedi pagg. 33)
Regolazione del limitatore di erogazione d'acqua calda. Un limitatore di erogazione di acqua calda in combinazione con le caldaie istantanee non è consigliabile.
-  **PROCEDURA** (vedi pagg. 34)
/ Hansgrohe raccomanda, di mattina oppure dopo lunghi tempi di stagnazione, di non utilizzare il primo mezzo litro come acqua potabile.
/ Non ruotare la bocca girevole più di 360° o il raccordo verrà danneggiato.
-  **PULITURA** (vedi pagg. 37)
-  **MANUTENZIONE** (vedi pagg. 37)
La valvola di non ritorno deve essere controllata regolarmente come da DIN EN 1717, secondo le normative nazionali e regionali (almeno una volta all'anno).
-  **INGOMBRI** (vedi pagg. 35)
-  **DIAGRAMMA FLUSSO** (vedi pagg. 35)
① Getto normale a pioggia
② Getto doccia
-  **PARTI DI RICAMBIO** (vedi pagg. 36)
XXX = Trattamento
000 = cromato
800 = acciaio inox acciaio
- ACCESSORI SPECIALI** (non contenuto nel volume di fornitura)
-  chiave per manutenzione #95910000 (vedi pagg. 36)
-  **SEGNO DI VERIFICA** (vedi pagg. 36)

PROBLEMA	POSSIBILE CAUSA	RIMEDIO
/ Miscelatore duro	/ Cartuccia difettosa	/ Sostituire la cartuccia
/ Miscelatore gocciola	/ Cartuccia difettosa	/ Sostituire la cartuccia
/ Perdita di acqua al set di fissaggio	/ I raccordi dei flessibili avvitati male nel corpo incasso / O-ring al raccordo flessibile difettoso	/ Avvitare i raccordi flessibili a mano / Sostituire l'o-ring
/ Temperatura dell'acqua calda	/ Limitazione dell'acqua calda regolata male	/ Regolare la limitazione dell'acqua calda

INDICACIONES DE SEGURIDAD

- ⚠ Durante el montaje deben utilizarse guantes para evitar heridas por aplastamiento o corte.
- ⚠ Grandes diferencias de presión en servicio entre agua fría y agua caliente deben equilibrarse.

INDICACIONES PARA EL MONTAJE











- / Antes del montaje se debe examinar el producto contra daños de transporte. Después de la instalación no se reconoce ningún daño de transporte o de superficie.
- / Los conductos y la grifería deben montarse, lavarse y comprobarse según las normas vigentes.
- / Es obligatorio el cumplimiento de las directrices de instalación vigentes en el país respectivo.

DATOS TÉCNICOS

Presión en servicio:	max. 1 MPa
Presión recomendada en servicio:	0,1 - 0,5 MPa
Presión de prueba:	1,6 MPa (1 MPa = 10 bar = 147 PSI)
Temperatura del agua caliente:	max. 70°C
Temp. recomendada del agua caliente:	65°C
Desinfección térmica:	max. 70°C/4 min

El producto ha sido concebido exclusivamente para agua potable.

DESCRIPCIÓN DE SÍMBOLOS

-  No utilizar silicona que contiene ácido acético!
-  **AJUSTE** (ver página 33)
Ajuste del límite de agua caliente. En combinación con calentadores continuos no es recomendable utilizar un bloqueo de agua caliente.
-  **MANEJO** (ver página 34)
/ Hansgrohe recomienda no utilizar el primer medio litro como agua potable por las mañanas o tras un largo periodo de inactividad.
/ No girar el caño más de 360° o el flexo podría resultar dañado.
-  **LIMPIAR** (ver página 37)
-  **MANTENIMIENTO** (ver página 37)
Las válvulas anti-retorno tienen que ser controladas regularmente según la norma DIN EN 1717, en acuerdo con las regulaciones nacionales o regionales (una vez al año, por lo menos).
-  **DIMENSIONES** (ver página 35)
-  **DIAGRAMA DE CIRCULACIÓN** (ver página 35)
① Chorro de lluvia
② Chorro de ducha
-  **REPUESTOS** (ver página 36)
XXX = Acabados
000 = cromado
800 = acero especial
- OPCIONAL** (no incluido en el suministro)
-  Llave para desmontar #95910000 (ver página 36)
-  **MARCA DE VERIFICACIÓN** (ver página 36)

PROBLEMA	CAUSA	SOLUCIÓN
/ Manecilla va dura	/ cartucho dañado	/ cambiar el cartucho
/ Grifo pierde agua	/ cartucho dañado	/ cambiar el cartucho
/ Pérdida de agua en el set de fijación	/ Conexión flexible mal atornillada al cuerpo del caño. / Daños en la junta de la conexión flexible	/ Apretar a mano la conexión flexible / cambiar juntas
/ Temperatura del agua caliente demasiado baja	/ tope de agua caliente mal	/ ajustar tope

⚠ VEILIGHEIDSIINSTRUCTIES

- ⚠ Bij de montage moeten ter voorkoming van knel- en snijwonden handschoenen worden gedragen.
- ⚠ Grote drukverschillen tussen de koud- en warmwatertoevoer dienen vermeden te worden.

MONTAGE-INSTRUCTIES

- / Vóór de montage moet het product gecontroleerd worden op transportschade. Na de inbouw wordt geen transport- of oppervlakteschade meer aanvaard.
- / De leidingen en armaturen moeten gemonteerd, gespoeld en gecontroleerd worden volgens de geldige normen.
- / De in de overeenkomstige landen geldende installatierichtlijnen moeten nageleefd worden.

TECHNISCHE GEGEVENS

Werkdruk: max.	max. 1 MPa
Aanbevolen werkdruk:	0,1 - 0,5 MPa
Getest bij:	1,6 MPa (1 MPa = 10 bar = 147 PSI)
Temperatuur warm water:	max. 70°C
Aanbevolen warm water temp.:	65°C
Thermische desinfectie:	max. 70°C/4 min

Het product is uitsluitend ontworpen voor drinkwater!

SYMBOOLBESCHRIJVING

-  Gebruik geen zuurhoudende silicone!
-  **INSTELLEN** (zie blz. 33)
Instellen van de warmwaterbegrenzing. In combinatie met een doorstromer is een warmwaterblokkering niet aanbevelenswaardig.
-  **BEDIENING** (zie blz. 34)
/ Hansgrohe raadt aan om 's morgens na langere stagnatietijden de eerste halve liter niet als drinkwater te gebruiken.
/ De uitloop niet meer dan 360° draaien, de slang kan daardoor beschadigd worden.
-  **REINIGEN** (zie blz. 37)
-  **ONDERHOUD** (zie blz. 37)
Keerleppen moeten volgens DIN EN 1717 regelmatig en volgens plaatselijk geldende eisen op het functioneren gecontroleerd worden. (Tenminste een keer per jaar)
-  **MATEN** (zie blz. 35)
-  **DOORSTROOMDIAGRAM** (zie blz. 35)
① Normale douchestraal
② Douchestraal
-  **SERVICE ONDERDELEN** (zie blz. 36)
XXX = Kleuren
000 = verchroomd
800 = RVS-look
- TOEBEHOREN** (behoort niet tot het leveringspakket)
 Servicesleutel #95910000 (zie blz. 36)
-  **KEURMERK** (zie blz. 36)

STORING	OORZAAK	OPLOSSING
/ Bediening zwaar	/ Kardoes defect of verkalkt	/ Kardoes uitwisselen
/ Mengkraan lekt	/ Kardoes defect	/ Kardoes uitwisselen
/ Lekkage op montageschacht	/ Aansluitslangen niet geheel in kraanhuis vastgedraaid / O-ring van aansluitslang defect	/ Aansluitslangen handvast aandraaien / O-ring uitwisselen
/ Temperatuur van warm water te laag	/ Heetwaterbegrenzer verkeerd ingesteld	/ Heetwaterbegrenzer instellen

⚠ SIKKERHEDSANVISNINGER

- ⚠ Ved monteringen skal der bruges handsker for at undgå kvæstelser og snitsår.
- ⚠ Større trykforskelle mellem koldt og varmt vand bør udjævnes.

MONTERINGSANVISNINGER

- / Før monteringen skal produktet kontrolleres for transportskader. Efter monteringen godkendes transportskader eller skader på overfladen ikke længere.
- / Ledningerne og armaturerne skal monteres, skylles og kontrolleres iht. de gældende standarder.
- / Installationsbestemmelserne, der gælder i det enkelte land, skal overholdes.

TEKNISKE DATA

Driftstryk:	max. 1 MPa
Anbefalet driftstryk:	0,1 - 0,5 MPa
Prøvetryk:	1,6 MPa (1 MPa = 10 bar = 147 PSI)
Varmtvandstemperatur:	max. 70°C
Anbefalet varmtvandstemperatur:	65°C
Termisk desinfektion:	max. 70°C/4 min

Produktet er udelukkende beregnet til drikkevand!

SYMBOLBESKRIVELSE

-  Der må ikke benyttes eddikesyreholdig silikone!
-  **FORINDSTILLING** (se s. 33)
Indstilling af varmvandsbegrænsningen. I forbindelse med gennemstrømningsvandvarmere anbefaler vi ikke en varmvandsspærre.
-  **BRUGSANVISNING** (se s. 34)
/ Hansgrohe anbefaler at den første halve liter om morgenen eller efter længere stagneringstider ikke anvendes som drikkevand.
/ Udløbstudnen bør ikke drejes mere end 360, da slangen ellers beskadiges.
-  **RENGØRING** (se s. 37)
-  **SERVICE** (se s. 37)
Ifølge DIN EN 1717 skal gennemstrømningsbegrænsere i overensstemmelse med nationale regler afprøves regelmæssigt (mindst en gang om året).
-  **MÅLENE** (se s. 35)
-  **GENNEMSTRØMNINGSDIAGRAM** (se s. 35)
① Normalstråle
② Brusestråle
-  **RESERVEDELE** (se s. 36)
XXX = Overflade
000 = Krom
800 = Stainless steel optic
- SPECIALTILBEHØR** (ikke med i leveringsomfang)
-  Monteringsnøgle #95910000 (se s. 36)
-  **GODKENDELSE** (se s. 36)

FEJL	ÅRSAG	HJÆLP
/ Grebet går trægt	/ Kartusche defekt, tilkalket	/ Udskift kartusche
/ Armaturet drypper	/ Defekt kartusche	/ Udskift kartusche
/ Armaturet er utæt ved befæstelsesdelene	/ Tilslutningsslangerne er ikke skruet korrekt op i armaturet. / Defekt o-ring på tilslutningsslange	/ Med håndkraft skures tilslutningsslangen strammere på. / Udskift o-ring
/ For lav varmtvands-temperatur	/ Varmtvandsbegrænsningen er forkert indstillet	/ Indstil varmtvandsbe-grænsningen

⚠ AVISOS DE SEGURANÇA

- ⚠ Durante a montagem devem ser utilizadas luvas de protecção, de modo a evitar ferimentos resultantes de entalamentos e de cortes.
- ⚠ Grandes diferenças entre as pressões das águas quente e fria devem ser compensadas.

AVISOS DE MONTAGEM











- / Antes da montagem deve-se controlar o produto relativamente a danos de transporte. Após a montagem não são aceites quaisquer danos de transporte ou de superfície.
- / As tubagens e a torneira têm que ser montadas, enxaguadas e verificadas de acordo com as normas em vigor.
- / A prescrições de instalação válidas nos respetivos países devem ser respeitadas.

DADOS TÉCNICOS

Pressão de funcionamento:	max. 1 MPa
Pressão de func. recomendada:	0,1 - 0,5 MPa
Pressão testada:	1,6 MPa (1 MPa = 10 bar = 147 PSI)
Temperatura da água quente:	max. 70°C
Temp. água quente recomendada:	65°C
Desinfecção térmica:	max. 70°C/4 min

Este produto foi única e exclusivamente concebido para água potável!

DESCRIÇÃO DO SÍMBOLO

-  Não utilizar silicone que contenha ácido acético!
-  **AFINAÇÃO** (ver página 33)
Ajuste do limitador de água quente. Em combinação com um esquentador, não é recomendável o uso de um bloqueio de água quente.
-  **FUNCIONAMENTO** (ver página 34)
 - / A Hansgrohe recomenda a não utilização do primeiro meio litro de água, de manhã ou após longas paragens, para fins de consumo.
 - / Não rode a bica mais do que 360° ou irá danificar o tubo flexível.
-  **LIMPEZA** (ver página 37)
-  **MANUTENÇÃO** (ver página 37)
As válvulas anti-retorno devem ser verificadas regularmente de acordo com a DIN EN 1717 segundo os regulamentos nacionais ou regionais (pelo menos uma vez por ano).
-  **MEDIDAS** (ver página 35)
-  **FLUXOGRAMA** (ver página 35)
 - ① operação normal
 - ② Chuveiro
-  **PEÇAS DE SUBSTITUIÇÃO** (ver página 36)
 - XXX = Acabamentos
 - 000 = cromado
 - 800 = aço imaculado ótica
- ACESSÓRIOS ESPECIAIS** (não incluído no volume de fornecimento)
 -  chave especial #95910000 (ver página 36)
 -  **MARCA DE CONTROLO** (ver página 36)

FALHA	CAUSA	SOLUÇÃO
/ Misturadora perra	/ Cartucho defeituoso, calcificado	/ Substituir o cartucho
/ Misturadora a pingar	/ Cartucho defeituoso	/ Substituir o cartucho
/ Perde água pela base rosçada	/ Tubos de ligação não estão completamente enroscados / O-ring dos tubo de ligação defeituoso	/ Apertar os tubos de ligação à mão / Trocar o-ring
/ Temperatura da água quente muito baixa	/ O limitador de temperatura está incorrectamente colocado	/ Regular o limitador de temperatura

Δ WSKAZÓWKI BEZPIECZEŃSTWA

- Δ Aby uniknąć zranień na skutek zgniecenia lub przecięcia, podczas montażu należy nosić rękawice ochronne.
- Δ Znaczne różnice ciśnień na dopływach ciepłej i zimnej wody muszą zostać wyrównane.

WSKAZÓWKI MONTAŻOWE

- / Przed montażem należy skontrolować produkt pod kątem szkód transportowych. Po montażu nie widać żadnych szkód transportowych ani szkód na powierzchni.
- / Przewody i armatura muszą być montowane, płukane i kontrolowane według obowiązujących norm.
- / Należy przestrzegać wytycznych instalacyjnych obowiązujących w danym kraju.

DANE TECHNICZNE

Ciśnienie robocze:	maks. 1 MPa
Zalecane ciśnienie robocze:	0,1 - 0,5 MPa
Ciśnienie próbne:	1,6 MPa
	(1 MPa = 10 bary = 147 PSI)
Temperatura wody gorącej:	maks. 70°C
Zalecana temperatura wody gorącej:	65°C
Dezynfekcja termiczna:	maks. 70°C / 4 min

Produkt przeznaczony wyłącznie do wody pitnej!

OPIS SYMBOLU

Nie stosować silikonów zawierających kwas octowy!



USTAWIANIE (patrz strona 33)

Ustawianie ogranicznika ciepłej wody. Używanie ogranicznika temperatury wody w połączeniu z przepływowym podgrzewaczem wody nie jest zalecane.



OBŚŁUGA (patrz strona 34)

/ Hansgrohe zaleca, by z rana lub po dłuższym czasie niekorzystania, pierwsze pół litra wody nie używać jako wody pitnej.

/ Nie kręcić wylotem bardziej niż o 360°, gdyż może dojść do uszkodzenia węża.



CZYSZCZENIE (patrz strona 37)



KONSERWACJA (patrz strona 37)

Zgodnie z normą DIN EN 1717, krajowymi i miejscowymi przepisami, działanie zabezpieczeń przed przepływem zwrotnym musi być kontrolowane (przynajmniej raz w roku).



WYMIARY (patrz strona 35)



SCHEMAT PRZEPŁYWU (patrz strona 35)

① Strumień normalny

② Strumień prysznica



CZĘŚCI SERWISOWE (patrz strona 36)

XXX = Kody kolorów

000 = chrom

800 = stal szlachetna

WYPOSAŻENIE SPECJALNE (Nie jest częścią dostawy)



Klucza montażowego #95910000 (patrz strona 36)



ZNAK JAKOŚCI (patrz strona 36)

USTERKA	PRZYCZYNA	POMOC
/ Uchwyt armatury pracuje z wysiłkiem	/ Uszkodzony wkład, zakamieniony	/ Wymiana wkładu
/ Armatura cieknie	/ Uszkodzony wkład	/ Wymiana wkładu
/ Wyciek wody przy mocowaniu od dołu	/ Zbyt słabo wkręcone wężyki w korpus	/ Dokręcić wężyki
	/ Uszkodzony o-ring przy węźle przyłączeniowym	/ Wymienić o-ring
/ Za niska temperatura ciepłej wody	/ Niewłaściwe ustawienie ogranicznik ciepłej wody	/ Ustawić ogranicznik ciepłej wody

⚠ BEZPEČNOSTNÍ POKYNY

- ⚠ Pro zabránění řezným zraněním a pohmožděninám je nutné při montáži nosit rukavice.
- ⚠ Je nutné vyrovnat velké rozdíly tlaku mezi přípoji studené a teplé vody.

POKYNY K MONTÁŽI











- / Před montáží je třeba produkt zkontrolovat, zda nebyl při transportu poškozen. Po zabudování nebudou uznány žádné škody způsobené transportem nebo poškození povrchu.
- / Vedení a armatura musí být namontovány, propláchnuty a otestovány podle platných norem.
- / Je třeba dodržovat montážní pravidla platná v dané zemi.

TECHNICKÉ ÚDAJE

Provozní tlak:	max. 1 MPa
Doporučený provozní tlak:	0,1 - 0,5 MPa
Zkušební tlak:	1,6 MPa (1 MPa = 10 bar = 147 PSI)
Teplota horké vody:	max. 70°C
Doporučená teplota horké vody:	65°C
Tepelná desinfekce:	max. 70°C / 4 min

Výrobky Hansgrohe jsou vhodné pro přímý kontakt s pitnou vodou.

POPIS SYMBOLŮ

-  Nepoužívat silikon s obsahem kyseliny octové!
-  **NASTAVENÍ** (viz strana 33)
Nastavení omezovače teplé vody. Ve spojení s průtokovým ohřivačem se použití uzávěru teplé vody nedoporučuje.
-  **OVLÁDÁNÍ** (viz strana 34)
/ Hansgrohe doporučuje ráno nebo po delších přestávkách nepoužívat prvního půl litru jako pitnou vodu.
/ Výtok neotáčet více než 360°, mohlo by dojít k poškození hadice.
-  **ČIŠTĚNÍ** (viz strana 37)
-  **ÚDRŽBA** (viz strana 37)
U zpětných ventilů se musí podle DIN EN 1717 v souladu s národními nebo regionálními předpisy testovat jejich funkčnost (alespoň jednou ročně).
-  **ROZMĚRY** (viz strana 35)
-  **DIAGRAM PRŮTOKU** (viz strana 35)
① Normální proud
② Ruční sprcha
-  **SERVISNÍ DÍLY** (viz strana 36)
XXX = Kód povrchové úpravy
000 = chrom
800 = nerezová ocel
- ZVLÁŠTNÍ PŘÍSLUŠENSTVÍ** (není součástí dodávky)
-  Servisní klíč #95910000 (viz strana 36)
-  **ZKUŠEBNÍ ZNAČKA** (viz strana 36)

PORUCHA	PŘÍČINA	ODSTRANĚNÍ
/ Armatura jde ztěžka	/ Kartuše je vadná, zanesená vodním kamenem	/ Kartuši vyměnit
/ Armatura odkapává	/ Kartuše je vadná	/ Kartuši vyměnit
/ výstup vody na upevňovacím násadci	/ přípojovací hadice nejsou dostatečně zašroubovány do tělesa	/ přípojovací hadice utáhnout rukou
	/ O-kroužek na přípojovací hadici je defektní	/ vyměnit O-kroužek
/ Nízká teplota teplé vody	/ Špatně nastavená zarážka pro teplotu vody	/ Seřadit zarážku pro teplotu vody

⚠ BEZPEČNOSTNÉ POKYNY

- ⚠ Pri montáži musíte nosiť rukavice, aby ste predišli pomliaždeninám a rezným poraneniam.
- ⚠ Veľké rozdiely v tlaku medzi prípojkami studenej a teplej vody musia byť vyrovnané.

POKYNY PRE MONTÁŽ

- / Pred montážou musíte produkt skontrolovať, či nebol počas transportu poškodený. Po zabudovaní nebudú uznané žiadne škody spôsobené transportom alebo poškodenia povrchu.
- / Ledningarna och blandaren måste monteras, spolás igenom och kontrolleras enligt de gällande normerna.
- / Je potrebné dodržiavať smernice o inštalácii, ktoré sú práve teraz platné v krajinách.

TECHNICKÉ ÚDAJE

Prevádzkový tlak:	max. 1 MPa
Doporučený prevádzkový tlak:	0,1 - 0,5 MPa
Skúšobný tlak:	1,6 MPa
	(1 MPa = 10 bar = 147 PSI)
Teplota teplej vody:	max. 70°C
Doporučená teplota teplej vody:	65°C
Termická dezinfekcia:	max. 70°C/4 min

Výrobok je koncipovaný výhradne pre pitnú vodu!

POPIS SYMBOLOV

Nepoužívať silikón s obsahom kyseliny octovej!



NASTAVENIE (viď strana 33)

Nastavenie obmedzenia teplej vody. V spojení s prietokovými ohrievačmi sa neodporúča použitie obmedzovača teplej vody.



OBSLUHA (viď strana 34)

/ Hansgrohe odporúča ráno a po dlhších dobách odstavky nepoužiť prvého pol litra vody ako pitnú vodu.

/ Odpad nepretáčať viac ako o 360°, lebo môže dôjsť k poškodeniu hadice.



ČISTENIE (viď strana 37)



ÚDRŽBA (viď strana 37)

Pri spätných ventiloch sa musí podľa DIN EN 1717 v súlade s národnými alebo regionálnymi predpismi testovať ich funkčnosť (aspoň raz ročne).



ROZMERY (viď strana 35)



DIAGRAM PRIETOKU (viď strana 35)

- ① Normálny prúd
- ② Sprchový prúd



SERVISNÉ DIELY (viď strana 36)

- XXX = Farebné označenie
- 000 = chróm
- 800 = ušľachtilá oceľ

ZVLÁŠTNE PRÍSLUŠENSTVO (nie je súčasťou dodávky)



Servisný kľúč #95910000 (viď strana 36)



OSVEDČENIE O SKÚŠKE (viď strana 36)

PORUCHA	PRÍČINA	POMOC
/ Armatúra "chodí" ťažko	/ Kartuša je poškodená, vápenaté usadeniny	/ Vymeniť kartušu
/ Z armatúry kvapká voda	/ Kartuša je poškodená	/ Vymeniť kartušu
/ Uhajanje vode ob prítidilnem nastavku	/ Hadice pripojenia nie sú celkom zaskrutkované do základného telesa	/ Hadice pripojenia dotiahnuť ručne
	/ Chybný O krúžok na pripojovacej hadici	/ Vymeniť O krúžok
/ Nízka teplota teplej vody	/ Nesprávne nastavená zarážka na teplú vodu	/ Nastavenie zarážky na teplú vodu

△ 安全技巧

- △ 装配时为避免挤压和切割受伤，必须戴上手套。
- △ 冷热水管间过大的压力差必须予以平衡。

安装提示



- / 安装前必须检查产品是否受到运输损害。安装后将不认可运输损害或表面损伤。
- / 管道和阀门必须根据通用标准进行安装、冲洗和检查。
- / 请遵守当地国家现行的安装规定。

技术参数

工作压强:	最大 1 MPa
推荐工作压强:	0,1 - 0,5 MPa
测试压强:	1,6 MPa (1 MPa = 10 bar = 147 PSI)
热水温度:	最大 70°C
推荐热水温度:	65°C
热力消毒:	最大 70°C / 4 分钟

该产品专为饮用水设计！

符号说明

-  请勿使用含有乙酸的硅胶！
-  调节 (参见第页 33)
热水温度调节。如果使用即热式喷头，则不建议安装热水阀门。
-  操作 (参见第页 34)
/ 汉斯格雅建议，清晨或在水流长时间停滞，前半升水不作饮用水使用。
/ 水嘴旋转不可超过360°，否则会导致软管受损。
-  清洗 (参见第页 37)
-  保养 (参见第页 37)
单向阀必须在符合国家或当地的法律的情况下按照DIN EN 1717定期检查（至少一年一次）。
-  大小 (参见第页 35)
-  流量示意图 (参见第页 35)
① 普通水流
② 花洒
-  备用零件 (参见第页 36)
XXX = 颜色代码
000 = 镀铬
800 = 不锈钢表面
- 选装附件 (不在供货范围内)
-  操作扳手 #95910000 (参见第页 36)
-  检验标记 (参见第页 36)

问题	原因	补救
/ 龙头不灵活	/ 阀芯损坏，结垢	/ 更换阀芯
/ 龙头滴水	/ 阀芯损坏	/ 更换阀芯
/ 水从螺纹底座中流出	/ 连接软管没有完全旋入基体 / 连接软管的O形环损坏	/ 用手拧紧连接软管 / 更换O形环
/ 热水温度过低	/ 温度限制器设置错误	/ 设置温度限制器

⚠ УКАЗАНИЯ ПО ТЕХНИКЕ БЕЗОПАСНОСТИ

- ⚠ Во время монтажа следует надеть перчатки во избежание прищемления и порезов.
- ⚠ донного клапа. Перед установкой смесителя необходимо регулировочными кранами выровнять давление холодной и горячей воды при помощи вентилей регулирующих подачу воды в квартиру.

УКАЗАНИЯ ПО МОНТАЖУ

- / Перед монтажом следует проверить изделие на предмет повреждений при перевозке. После монтажа претензии о возмещении ущерба за повреждения при перевозке или повреждения поверхностей не принимаются.
- / Трубы и арматура должны быть установлены, промыты и проверены в соответствии с действующими нормами.
- / Необходимо соблюдать требования по монтажу, действующие в соответствующих странах.

ТЕХНИЧЕСКИЕ ДАННЫЕ

Рабочее давление:	не более. 1 МПа
Рекомендуемое рабочее давление:	0,1 - 0,5 МПа
Давление:	1,6 МПа
	(1 МПа = 10 bar = 147 PSI)
Температура горячей воды:	не более. 70°C
Рекомендуемая темп. гор. воды:	65°C
Термическая дезинфекция:	не более. 70°C/4 мин

Изделие предназначено исключительно для питьевой воды!

ОПИСАНИЕ СИМВОЛОВ

-  Не применяйте силикон, содержащий уксусную кислоту.
-  **ПОДГОНКА** (см. стр. 33)
Регулировка ограничителя горячей воды. В сочетании с проточными нагревателями не рекомендуется использовать блокировку воды.
-  **ЭКСПЛУАТАЦИЯ** (см. стр. 34)
/ Hansgrohe рекомендует по утрам либо после длительного перерыва в использовании не использовать первые поллитра воды для питья.
/ Не поворачивайте излив более, чем на 360°, поскольку иначе можно повредить шланг.
-  **ОЧИСТКА** (см. стр. 37)
-  **ТЕХНИЧЕСКОЕ ОБСЛУЖИВАНИЕ** (см. стр. 37)
Защита обратного тока должна регулярно проверяться (минимум один раз в год) по стандарту DIN EN 1717 или в соответствии с национальными или региональными нормативами
-  **РАЗМЕРЫ** (см. стр. 35)
-  **СХЕМА ПОТОКА** (см. стр. 35)
① Нормальная струя
② Струя душа
-  **КОМПЛЕКТ** (см. стр. 36)
XXX = Цветная кодировка
000 = хром
800 = сталь
- СПЕЦИАЛЬНЫЕ ПРИНАДЛЕЖНОСТИ**
(не включено в объем поставки)
 Сервисный ключ #95910000 (см. стр. 36)
-  **ЗНАК ТЕХНИЧЕСКОГО КОНТРОЛЯ** (см. стр. 36)

НЕИСПРАВНОСТЬ	ПРИЧИНА	УСТРАНЕНИЕ НЕИСПРАВНОСТИ
/ Арматура работает с усилием	/ Картридж неисправен, засорение накипью	/ Замените картридж
/ Арматура протекает	/ Картридж неисправен	/ Замените картридж
/ Выход воды у основания крепления	/ Шланги подключения не полностью завернуты в корпус / Уплотнительное кольцо круглого сечения на соединительном шланге неисправно	/ Затяните шланги подключения вручную / Замените уплотнительное кольцо круглого сечения
/ Температура горячей воды слишком низкая	/ Ограничение горячей воды отрегулировано неправильно	/ Отрегулируйте ограничение горячей воды

⚠ BIZTONSÁGI UTASÍTÁSOK

- ⚠ A szerelésnél a zúzódások és vágási sérülések elkerülése érdekében kesztyűt kell viselni.
- ⚠ A hidegvíz- és a melegvíz-csatlakozások közötti nagy nyomáskülönbséget kikell egyenlíteni!

SZERELÉSI UTASÍTÁSOK

- / A szerelés előtt ellenőrizni kell, hogy a terméknek nincs-e szállítási sérülése. Beépítés után a szállítási- vagy felületi sérüléseket nem ismerik el.
- / A vezetékeket és a csaptelepet az érvényes szabványoknak megfelelően kell felszerelni, öblíteni és ellenőrizni
- / Az egyes országokban érvényes installációs irányelveket be kell tartani.

MŰSZAKI ADATOK

Üzemi nyomás:

Ajánlott üzemi nyomás:

Nyomáspróba:

Forróvíz hőmérséklet:

Forróvíz javasolt hőmérséklete:

Termikus fertőtlenítés:

max. 1 MPa
0,1 - 0,5 MPa
1,6 MPa
(1 MPa = 10 bar = 147 PSI)
max. 70°C
65°C
max. 70°C/4 perc

A terméket kizárólag ivóvízhez tervezték!

SZIMBÓLUMOK LEÍRÁSA



Ne használjon ecetsavtartalmú szilikon!



BEÁLLÍTÁS (lásd a oldalon 33)

A meleg víz korlátozás beállítása. Átfolyós vízmelegítőknél meleg víz korlátozó használata nem ajánlott.



HASZNÁLAT (lásd a oldalon 34)

/ A Hansgrohe azt ajánlja, hogy hosszabb állási idő után az első fél liter vizet ne használja ivóvízként.

/ A kifolyót ne fordítsa 360°-nál tovább, mert különben a tömlő megsérülhet.



TISZTÍTÁS (lásd a oldalon 37)



KARBANTARTÁS (lásd a oldalon 37)

A visszafolyásgátlók működése a DIN EN 1717 szabványnak megfelelően, a nemzeti vagy területi rendelkezésekkel összhangban, évente egyszer ellenőrizendő!



MÉRETET (lásd a oldalon 35)



ÁTFOLYÁSI DIAGRAMM (lásd a oldalon 35)

① Normálsugár

② Zuhansugár



TARTOZÉKOK (lásd a oldalon 36)

XXX = Színkódolás

000 = króm

800 = acéloptika

EGYÉB TARTOZÉK (a szállítási egység nem tartalmazza)



Szervíz kulcs #95910000 (lásd a oldalon 36)



VIZSGAJEL (lásd a oldalon 36)

HIBA	OK	MEGOLDÁS
/ Nehezen nyitható a csap.	/ A kerámiabetét meghibásodott, elvízkövesedett.	/ A kerámiabetétet ki kell cserélni.
/ Csöpög a csap.	/ A kerámiabetét meghibásodott.	/ A kerámiabetétet ki kell cserélni.
/ Vízkilépés a rögzítőrudon	/ A csatlakozótömlők nincsenek teljesen becsavarozva az akapteszbe	/ A csatlakozótömlőket kézzel meghúzni
	/ Csatlakozótömlő tömítőgyűrűje meghibásodott	/ Tömítőgyűrű kicserélése
/ túl alacsony melegvíz hőmérséklet	/ A melegvíz szabályozó rosszul van beállítva.	/ A melegvíz szabályozót újra be kell állítani.

⚠ TURVALLISUUSOHJEET

- ⚠ Asennuksessa on käytettävä käsiineitä puristumien ja viiltojen aiheuttamien tapaturmien estämiseksi.
- ⚠ Suuret paine-erot kylmä- ja kuumavesiliitäntöjen välillä on tasattava.

ASENNUSOHJEET

- / Ennen asennusta on tarkastettava tuotteen mahdolliset kuljetusvahingot. Asennuksen jälkeen kuljetus- ja pintavaurioita ei hyväksytä.
- / Putket ja hana on asennettava, huuhdeltava ja tarkastettava voimassa olevien standardien mukaisesti.
- / Jokaisessa maassa on noudatettava siellä päteviä asennusohjeita.

TEKNISET TIEDOT

Käyttöpaine:	maks. 1 MPa
Suosittelut käyttöpaine:	0,1 - 0,5 MPa
Koestuspaine:	1,6 MPa (1 MPa = 10 bar = 147 PSI)
Kuuman veden lämpötila:	maks. 70°C
Kuuman veden suosituslämpötila:	65°C
Lämpödesinfektio:	maks. 70°C/4 min

Tuote on suunniteltu käytettäväksi ainoastaan juomaveden kanssa!

MERKIN KUVAUS

-  Älä käytä etikkahappopitoista silikonia!
-  **SÄÄTÖ** (katso sivu 33)
Lämpötilan rajoittimen säätäminen. Emme suosittele käyttämään lämpötilan rajoittinta vedenlämmittimen (läpivirtauskuumennin) yhteydessä.
-  **KÄYTTÖ** (katso sivu 34)
/ Hansgrohe suosittelee, että ensimmäistä puolta litraa ei käytetä juomavedenä aamuisin eikä silloin, kun laitetta ei ole käytetty pitkään aikaan.
/ Älä käännä juoksuputkea enempää kuin 360°, koska muuten letku voi vahingoittua.
-  **PUHDISTUS** (katso sivu 37)
-  **HUOLTO** (katso sivu 37)
Vastaventtiilien toiminta on tarkastettava säännöllisesti paikallisten ja kansallisten määräysten mukaisesti (DIN EN 1717, vähintään kerran vuodessa).
-  **MITAT** (katso sivu 35)
-  **VIRTAUSDIAGRAMMI** (katso sivu 35)
① Normaalisuihku
② Suihku
-  **VARAOSAT** (katso sivu 36)
XXX = Värikoodaus
000 = kromi
800 = inox-optinen
- ERITYISVARUSTE** (ei kuulu toimitukseen)
-  Service-avain #95910000 (katso sivu 36)
-  **KOESTUSMERKKI** (katso sivu 36)

HÄIRIÖ	SYY	TOIMENPIDE
/ Hana on raskaskäyttöinen	/ Patruuna rikki, kalkkikerrostumia	/ Vaihda patruuna
/ Hanasta tippuu vettä	/ Patruuna rikki	/ Vaihda patruuna
/ Vettä valuu kiinnityskauluksesta	/ Liitosletkut eivät ole kierretty kiinni perusrunkoon pohjaan asti	/ Kierrä liitosletkut kiinni käsikireyteen
	/ Liitosletkun O-rengas on rikki	/ Vaihda O-rengas
/ Lämminveden lämpötila liian alhainen	/ Lämminveden rajoitin väärin säädetty	/ Sääädä lämminveden rajoitin

⚠ SÄKERHETSANVISNINGAR

- ⚠ Handskar ska bäras under monteringsarbetet så att man kan undvika kläm- och skärskadorna werden.
- ⚠ Stora tryckskillnader mellan anslutningarna för varmt och kallt vatten måste utjämnas.

MONTERINGSANVISNINGAR









- / Det måste undersökas om produkten har transportskador innan den monteras. Efter monteringen accepteras inga transport- eller ytskiktsskador.
- / Ledningarna och blandaren måste monteras, spolats igenom och kontrolleras enligt de gällande normerna.
- / De installationsriktlinjer som gäller i länderna ska följas.

TEKNISKA DATA

Driftstryck:	max. 1 MPa
Rek. driftstryck:	0,1 - 0,5 MPa
Tryck vid provtryckning:	1,6 MPa (1 MPa = 10 bar = 147 PSI)
Varmvattentemperatur:	max. 70°C
Rek. varmvattentemp.:	65°C
Termisk desinfektion:	max. 70°C / 4 min

Produkten är enbart avsedd för dricksvatten!

SYMBOLFÖRKLARING

-  Använd inte silikon som innehåller ättiksyra!
-  **JUSTERING** (se sidan 33)
Ställa in varmvattenregleringen. Tillsammans med varmvattenberedare rekommenderas inte en varmvattenspärr.
-  **HANTERING** (se sidan 34)
/ Hansgrohe rekommenderar att den första halvlitern inte används som dricksvatten på morgonen eller efter längre perioder utan användning.
/ Vrid inte blandaren mer än 360° eftersom slangen annars kan skadas.
-  **RENGÖRING** (se sidan 37)
-  **SKÖTSEL** (se sidan 37)
Backventilens funktion måste kontrolleras regelbundet enligt nationella eller regionala bestämmelser i enlighet med DIN EN 1717 (minst en gång per år).
-  **MÅTTEN** (se sidan 35)
-  **FLÖDESSCHEMA** (se sidan 35)
① Normalstråle
② Duschstråle
-  **RESERVDELAR** (se sidan 36)
XXX = Färgkodning
000 = krom
800 = rostfri-optik
- SPECIALTILLBEHÖR** (medföljer ej leveransen)
-  Servicenyckel #95910000 (se sidan 36)
-  **TESTSIGILL** (se sidan 36)

STÖRNING	ORSAK	ÅTGÄRD
/ Blandare är trög	/ Patron defekt, förkalkad	/ Byt ut patron
/ Blandare droppar	/ Patron defekt	/ Byt ut patron
/ Vatten kommer ut vid monteringsstaget	/ Anslutningsslangar inte helt inskruvade i grundkonstruktionen / O-ring på anslutningsslang defekt	/ Drag fast anslutningsslangar för hand. / Byt ut O-ring
/ Varmvattentemperaturen är för låg	/ Varmvattenreglering felaktigt inställd	/ Ställ in varmvattenreglering

⚠ SAUGUMO TECHNIKOS NURODYMAI

- ⚠ Apsaugai nuo užspaudimo ir įsipjovimo montavimo metu mūvėkite pirštines.
- ⚠ Turi būti išlyginti šalto ir karšto slėgio nelygumai.

MONTAVIMO INSTRUKCIJA

- / Prieš montuojant būtina patikrinti, ar gaminys nebuvo pažeistas transportavimo metu. Sumontavus pretenzijos dėl transportavimo ir paviršiaus pažeidimų nepriimamos.
- / Vamzdžiai ir sujungimai turi būti montuojami, plaunami ir tikrinami pagal galiojančias normas.
- / Laikykites atitinkamoje šalyje galiojančių direktyvų dėl įrengimo.

TECHNINIAI DUOMENYS

Darbinis slėgis:	ne daugiau kaip 1 MPa
Rekomenduojamas slėgis:	0,1 - 0,5 MPa
Bandomasis slėgis:	1,6 MPa (1 MPa = 10 barų = 147 PSI)
Karšto vandens temperatūra:	ne daugiau kaip 70°C
Rekomenduojama karšto vandens temperatūra:	65°C
Terminis dezinfekavimas:	ne daugiau kaip 70°C/4 min

Produktas skirtas tik geriamajam vandeniui!

SIMBOLIO APRAŠYMAS

-  Nenaudokite silikono, kurio sudėtyje yra acto rūgšties!
-  **REGULIAVIMAS** (žr. psl. 33)
Karšto vandens ribojimas. Kartu su cirkuliaciniais šildytuvais nerekomenduojama naudoti karšto vandens blokavimo įtaisų.
-  **EKSPLOATACIJA** (žr. psl. 34)
/ Naudojant po ilgesnės pertraukos, „Hansgrohe“ rekomenduoja pirmo pusės litro vandens nevirtoti kaip geriamojo.
/ Nesukite čiaupo daugiau kaip 360°, nes galite pažeisti žarną.
-  **VALYMAS** (žr. psl. 37)
-  **TECHNINIS APTARNAVIMAS** (žr. psl. 37)
Atbulinio vožtuvo apsauga privalo būti tikrinama reguliariai (mažiausiai kartą per metus) pagal DIN EN1717 arba pagal galiojančias nacionalines arba regionines normas.
-  **IŠMATAVIMAI** (žr. psl. 35)
-  **PRALAUDIMO DIAGRAMA** (žr. psl. 35)
① Normali srovė
② Dušo srovė
-  **ATSARGINĖS DALYS** (žr. psl. 36)
XXX = Spalvos
000 = chrom
800 = plienas
- SPECIALŪS PRIEDAI** (nėra pridodama)
-  Techninės priežiūros raktas #95910000 (žr. psl. 36)
-  **BANDYMO PAŽYMA** (žr. psl. 36)

GEDIMAS	PRIEŽASTIS	PRIEMONĖ
/ Sunkiai sukiojama rankenėlė	/ Kasetė pažeista, užkalkėjusi	/ Pakeisti kasetę
/ Maišytuvą praleidžia vandenį	/ Kasetė pažeista	/ Pakeisti kasetę
/ Prateka vanduo per tvirtinimo kotą	/ Prijungimo žarnos nepilnai įsuktos į korpusą	/ Prijungimo žarnas prisukti ranka
	/ Pajungimo žarnos tarpinė pažeista	/ tarpinę pakeisti
/ Per maža karšto vandens temperatūra	/ Neteisingai nustatytas karšto vandens ribotuvą	/ Nustatyti karšto vandens ribotuvą

⚠ SIGURNOSNE UPUTE

- ⚠ Prilikom montaže se radi sprječavanja prignječenja i posjekotina moraju nositi rukavice.
- ⚠ Velika razlika u pritisku između vruće i hladne vode mora biti izbalansirana.

UPUTE ZA MONTAŽU

- / Prije montaže mora se provjeriti je li proizvod oštećen prilikom transporta. Nakon ugradnje se ne priznaju nikakve reklamacije koje se odnose na površinska i transportna oštećenja.
- / Cijevi i armatura moraju biti postavljeni, isprani i testirani prema važećim normama.
- / Obvezno se moraju uvažiti propisi o instalacijama koji vrijede u dotičnoj zemlji.

TEHNIČKI PODATCI

Najveći dopušteni tlak:

Preporučeni tlak:

Probni tlak:

Temperatura vruće vode:

Preporučena temperatura vruće vode:

Termička dezinfekcija:

tlak 1 MPa
0,1 - 0,5 MPa
1,6 MPa
(1 MPa = 10 bar = 147 PSI)
tlak 70°C
65°C
tlak 70°C/4 min

Proizvod je koncipiran isključivo za pitku vodu!

OPIS SIMBOLA

 Nemojte koristiti silikon koji sadrži octenu kiselinu!

 **REGULACIJA** (pogledaj stranicu 33)
Namještanje limitera tople vode. U kombinaciji s protočnim bojlerima nije preporučljiva primjena sustava za blokiranje dotoka tople vode.

 **UPOTREBA** (pogledaj stranicu 34)
/ Hansgrohe preporuča da ujutro ili nakon duljeg nekorisćenja prvih 1/2 litre vode ne upotrebljavate za piće.
/ Slavina se ne smije zavrtati više od 360° jer bi se u protivnom mogla oštetiti cijev

 **ČIŠĆENJE** (pogledaj stranicu 37)

 **ODRŽAVANJE** (pogledaj stranicu 37)
Ispravnost nepovratnog ventila mora se redovito provjeravati prema standardu DIN EN 1717 i u skladu sa važećim propisima (najmanje jednom godišnje).

 **MJERE** (pogledaj stranicu 35)

 **DIJAGRAM PROTOKA** (pogledaj stranicu 35)
① Normalni mlaz
② mlaz

 **REZERVNI DJELOVI** (pogledaj stranicu 36)
XXX = Boje
000 = krom
800 = plemeniti čelik

POSEBNI PRIBOR (Nije sadržano u isporuci!)

 Servisni odvijač #95910000 (pogledaj stranicu 36)

 **OZNAKA TESTIRANJA** (pogledaj stranicu 36)

GREŠKA	UZROK	OTKLANJANJE
/ Ručica se zaglavila	/ Neispravan uložak Taloženje kamenca	/ Zamijenite uložak
/ Slavina kaplje	/ Neispravan uložak	/ Zamijenite uložak
/ Voda izlazi na dijelu gdje je slavina učvršćena	/ Priključna crijeva nisu potpuno učvršćena na tijelo	/ Priključna crijeva učvrstite rukom
	/ O-prsteni priključnih crijeva su neispravni	/ Zamijenite O-prsten
/ Preniska temperatura tople vode	/ Limiter vruće vode nije dobro podešen	/ Podesite limiter vruće vode

⚠ GÜVENLİK UYARILARI

- ⚠ Montaj esnasında ezilme ve kesilme gibi yaralanmaları önlemek için eldiven kullanılmalıdır.
- ⚠ Sıcak ve soğuk su bağlantıları arasında büyük basınç farklılıkları varsa, bu basınç farklılıklarının dengelenmesi gerekir.

MONTAJ AÇIKLAMALARI

- / Montaj işleminden önce ürün nakliye hasarları yönünden kontrol edilmelidir. Montaj işleminden sonra nakliye veya yüzey hasarları için sorumluluk üstlenilmemektedir.
- / Boruların ve armatürün montajı, yıkanması ve kontrolü geçerli normlara göre yapılmalıdır.
- / Ülkelerde geçerli kurulum yönetmeliklerine riayet edilmelidir.

TEKNİK BİLGİLER

İşletme basıncı:
Tavsiye edilen işletme basıncı:
Kontrol basıncı:

Sıcak su sıcaklığı:
Tavsiye edilen su ısısı:
Termik dezenfeksiyon:

Ürün sadece şebeke suyu için tasarlanmıştır!

azami 1 MPa
0,1 - 0,5 MPa
1,6 MPa
(1 MPa = 10 bar = 147 PSI)
azami 70°C
65°C
azami 70°C/4 dak

SİMGE AÇIKLAMASI

Asetik asit içeren silikon kullanmayın!



AYARLAMA (bakınız sayfa 33)

Sıcak su sınırlamasının ayarlanması. Sıcak su kilidinin sürekli ısıtıcıyla kullanılması tavsiye edilmez.



KULLANIMI (bakınız sayfa 34)

- / Hansgrohe sabahları uzun durgunluk süresi sonrasında ilk yarım litre suyun içme suyu olarak kullanılmamasını önerir.
- / Aksi takdirde hortum zarar görebileceği için çıkışı 360°'den fazla döndürmeyin.



TEMİZLEME (bakınız sayfa 37)



BAKIM (bakınız sayfa 37)

DIN EN 1717 ve ulusal standartlar doğrultusunda Çek valfler düzenli olarak kontrol edilmelidir. (en az yılda bir kez)



ÖLÇÜLERİ (bakınız sayfa 35)



AKIŞ DİYAGRAMI (bakınız sayfa 35)

- ① Normal duş
- ② Püskürtme başlığı



YEDEK PARÇALAR (bakınız sayfa 36)

- XXX = Renkler
- 000 = krom
- 800 = paslanmaz çelik - optik

ÖZEL AKSESUARLAR (Teslimat kapsamına dahil değildir)



Servis anahtarı #95910000 (bakınız sayfa 36)



KONTROL İŞARETİ (bakınız sayfa 36)

ARIZA	SEBEP	YARDIM
/ Batarya kullanımı ağırlaşıyor	/ Kartuş Bozulmuş ve kireçlenmiş olabilir	/ Kartuşu değiştirin
/ Batarya su damlatıyor	/ Kartuş bozuk olabilir	/ Kartuşu değiştirin
/ Sabitleme kutusundan su çıkışı	/ Bağlantı hortumları ana gövdeye tamamen vidalanmamış	/ Bağlantı hortumlarını elinizle sıkın
	/ Bağlantı hortumundaki O-ring arızalı	/ O-ringi değiştirin
/ Sıcak suyun derecesi çok düşük	/ Isı limitleyici düzgün çalışmıyor	/ Isı limitleyiciyi yeniden ayarlayın

⚠ INSTRUCȚIUNI DE SIGURANȚĂ

- ⚠ La montare utilizați mănuși pentru evitarea contuziunilor și tăierii mâinilor.
- ⚠ Diferențele de presiune mari între alimentarea cu apă rece și apă caldă trebuie echilibrate.

INSTRUCȚIUNI DE MONTARE

- / Înainte de instalare verificați, dacă produsul prezintă deteriorări de transport. După instalare garanția nu acoperă deteriorările de transport și cele de suprafață.
- / Conductele și bateriile trebuie montate, spălate și verificate conform normelor în vigoare.
- / Respectați reglementările referitoare la instalare valabile în țara respectivă.

DATE TEHNICE

Presiune de funcționare:

Presiune de funcționare recomandată:

Presiune de verificare:

Temperatura apei calde:

Temperatura recomandată a apei calde:

Dezinfecție termică:

max. 1 MPa
0,1 - 0,5 MPa
1,6 MPa
(1 MPa = 10 bar = 147 PSI)
max. 70°C
65°C
max. 70°C/4 min

Produsul este destinat exclusiv pentru apă potabilă.

DESCRIEREA SIMBOLURILOR



Nu utilizați silicon cu conținut de acid acetic!



REGLARE (vezi pag. 33)

Reglarea limitatorului de apă caldă. Nu se recomandă folosirea unui limitator de apă caldă în combinație cu un boiler instant.



UTILIZARE (vezi pag. 34)

/ Hansgrohe vă recomandă, ca dimineața sau după perioade mai lungi de pauză să nu folosiți prima jumătate de litru de apă pentru băut.

/ Nu rotiți pipa mai mult de 360°, altfel riscați deteriorarea furtunului.



CURĂȚARE (vezi pag. 37)



ÎNTREȚINERE (vezi pag. 37)

Supapele antiretur trebuie verificate regulat conform DIN EN 1717 și standardele naționale sau regionale (cel puțin o dată pe an).



DIMENSIUNI (vezi pag. 35)



DIAGRAMA DE DEBIT (vezi pag. 35)

① jet normal

② Cap de jet



PIESE DE SCHIMB (vezi pag. 36)

XXX = Coduri de culori

000 = crom

800 = oțel inox

ACCESORII OPȚIONALE (nu este inclus în setul livrat)



Cheie service #95910000 (vezi pag. 36)



CERTIFICAT DE TESTARE (vezi pag. 36)

DERANJAMENT	CAUZA	MĂSURI DE REMEDIERE
/ Bateria se mișcă dificil	/ Cartuș defect din cauza depunerilor de calcar	/ Schimbați cartușul.
/ Bateria picură	/ Cartuș defect	/ Schimbați cartușul.
/ Scurgere de apă la șaftul de fixare.	/ Furtunurile de racordare nu sunt bine înșurubate în corpul bateriei.	/ Strângeți cu mâna furtunurile de racordare.
	/ Inelul O de la furtunul de racord defect	/ Schimbați inelul O.
/ Temperatura apei calde este prea mică	/ Limitarea temperaturii apei calde setată incorect.	/ Setați limitarea temperaturii apei calde.

⚠ ΥΠΟΔΕΙΞΕΙΣ ΑΣΦΑΛΕΙΑΣ

- ⚠ Για να αποφύγετε τραυματισμούς κατά τη συναρμολόγηση πρέπει να φοράτε γάντια.
- ⚠ Οι διαφορές της πίεσης μεταξύ της σύνδεσης κρύου και ζεστού νερού θα πρέπει να αντισταθμίζονται.

ΟΔΗΓΙΕΣ ΣΥΝΑΡΜΟΛΟΓΗΣΗΣ

- / Πριν τη συναρμολόγηση πρέπει να εξεταστεί το προϊόν για ζημιές μεταφοράς. Μετά την εγκατάσταση δεν αναγνωρίζονται ζημιές από τη μεταφορά ή επιφανειακές ζημιές.
- / Οι σωλήνες και η μπαταρία πρέπει να τοποθετηθούν σύμφωνα με τα ισχύοντα πρότυπα, να τεθούν υπό πίεση και να δοκιμαστούν.
- / Θα πρέπει να τηρούνται οι οδηγίες εγκατάστασης που ισχύουν σε κάθε κράτος.

ΤΕΧΝΙΚΑ ΧΑΡΑΚΤΗΡΙΣΤΙΚΑ

Λειτουργία πίεσης:

Συνιστώμενη λειτουργία πίεσης:

Πίεση ελέγχου:

Θερμοκρασία ζεστού νερού:

Συνιστώμενη θερμοκρασία ζεστού νερού:

Θερμική απολύμανση:

έως 1 MPa

0,1 - 0,5 MPa

1,6 MPa

(1 MPa = 10 bar = 147 PSI)

έως 70°C

65°C

έως 70°C / 4 min

Το προϊόν έχει σχεδιαστεί αποκλειστικά για πόσιμο νερό!

ΠΕΡΙΓΡΑΦΗ ΣΥΜΒΟΛΩΝ

Μην χρησιμοποιείτε σιλικόνη που περιέχει οξικό οξύ!



ΡΥΘΜΙΣΗ (βλ. Σελίδα 33)

Ρύθμιση του δοσομετρητή ζεστού νερού. Δεν συνιστάται η διάταξη φραγής ζεστού νερού σε συνδυασμό με ταχυθερμοσίφωνα.



ΧΕΙΡΙΣΜΟΣ (βλ. Σελίδα 34)

/ Η Hansgrohe συνιστά το πρωί ή μετά από μεγάλα χρονικά διαστήματα αχρησίας να μην χρησιμοποιείτε το πρώτο μισό λίτρο νερό σαν πόσιμο.

/ Μην περιστρέψετε την αποχέτευση πέραν των 360°, καθώς μπορεί να προκληθεί βλάβη στο σωλήνα παροχής.



ΚΑΘΑΡΙΣΜΟΣ (βλ. Σελίδα 37)



ΣΥΝΤΗΡΗΣΗ (βλ. Σελίδα 37)

Οι βαλβίδες αντεπιστροφής πρέπει να ελέγχονται τακτικά ως προς τη λειτουργία τους, σύμφωνα με το πρότυπο DIN EN 1717, σε σχέση με τους ισχύοντες εθνικούς ή τοπικούς κανόνες (το ελάχιστο μια φορά το χρόνο) .



ΔΙΑΣΤΑΣΕΙΣ (βλ. Σελίδα 35)



ΔΙΑΓΡΑΜΜΑ ΡΟΗΣ (βλ. Σελίδα 35)

① Κανονική δέσμη νερού

② Δέσμη καταιονισμού



ΑΝΤΑΛΛΑΚΤΙΚΑ (βλ. Σελίδα 36)

XXX = Χρώματα

000 = Επιχρωμωμένο

800 = οπτική ανοξειδώτου χάλυβα

ΕΙΔΙΚΑ ΑΞΕΣΟΥΑΡ (δεν περιλαμβάνεται στον παραδοτέο εξοπλισμό)



Κλειδί για σέρβις #95910000 (βλ. Σελίδα 36)



ΣΗΜΑ ΕΛΕΓΧΟΥ (βλ. Σελίδα 36)

ΒΛΑΒΗ	ΑΙΤΙΑ	ΔΙΟΡΘΩΣΗ
/ Σκληρή μπαταρία (μείκτης)	/ Ελαττωματικό φυσίγγιο, άλατα	/ Αλλαγή φυσιγγίου
/ Η μπαταρία στάζει	/ Ελαττωματικό φυσίγγιο	/ Αλλαγή φυσιγγίου
/ Διαρροή νερού στον άξονα στερέωσης	/ Οι σωλήνες σύνδεσης δεν είναι πλήρως βιδωμένοι στο βασικό κορμό	/ Σφίξτε τους σωλήνες σύνδεσης με το χέρι
	/ Ο στρογγυλός δακτύλιος στο σωλήνα σύνδεσης είναι ελαττωματικός	/ Αλλάξτε το στρογγυλό δακτύλιο
/ Χαμηλή θερμοκρασία ζεστού νερού	/ Λάθος ρύθμιση της περιοριστικής διάταξης ζεστού νερού	/ Ρυθμίστε την περιοριστική διάταξη του ζεστού νερού



⚠ VARNOSTNA OPOZORILA

- ⚠ Pri montaži je treba nositi rokavice, da se preprečijo poškodbe zaradi zmečkanja ali urezov.
- ⚠ Velike razlike v tlaku med priključkom za mrzlo in priključkom za toplo vodo je potrebno izravnati.

NAVODILA ZA MONTAŽO

- / Pred montažo je treba izdelek preveriti glede morebitnih transportnih poškodb. Po vgradnji transportne ali površinske poškodbe ne bodo več priznane.
- / Cevi in armaturo je treba montirati, izprati in preveriti po veljavnih standardih.
- / Upoštevanje je treba pravilnike o inštalacijah, ki veljajo v posamezni državi.

TEHNIČNI PODATKI

Delovni tlak:	maks. 1 MPa
Priporočeni delovni tlak:	0,1 - 0,5 MPa
Preskusni tlak:	1,6 MPa (1 MPa = 10 bar = 147 PSI)
Temperatura tople vode:	maks. 70°C
Priporočena temperatura tople vode:	65°C
Termična dezinfekcija:	maks. 70°C/4 min

Proizvod je zasnovan izključno za sanitarno vodo!

OPIS SIMBOLA

-  Ne smete uporabiti silikona, ki vsebuje ocatno kislino!
-  **JUSTIRANJE** (glejte stran 33)
Nastavitev omejevalnika tople vode. V povezavi s pretočnimi grelniki uporaba zapore tople vode ni priporočljiva.
-  **UPRAVLJANJE** (glejte stran 34)
/ Hansgrohe priporoča, da zjutraj ali po daljšem času stagnacije prvega pol litra vode ne uporabite kot pitno vodo.
/ Izliva ne obračajte za več kot 360°, saj lahko sicer poškodujete gibko cev.
-  **ČIŠČENJE** (glejte stran 37)
-  **VZDRŽEVANJE** (glejte stran 37)
Delovanje protipovratnega ventila je potrebno v skladu z DIN EN 1717 in skladno z državnimi in regionalnimi določili redno testirati (najmanj enkrat letno).
-  **MERE** (glejte stran 35)
-  **DIAGRAM PRETOKA** (glejte stran 35)
① Normalen curek
② Pršilni curek
-  **REZERVNI DELI** (glejte stran 36)
XXX = Barve
000 = krom
800 = videz legiranega jekla
- POSEBEN PRIBOR** (Ni vključeno)
-  Servisni ključ #95910000 (glejte stran 36)
-  **PRESKUSNI ZNAK** (glejte stran 36)

NAPAKA	VZROK	POMOČ
/ Težko premikanje armature	/ Pokvarjen vložek, poapneno	/ Zamenjajte vložek
/ Iz armature kaplja	/ Pokvarjen vložek	/ Zamenjajte vložek
/ Uhajanje vode ob pritrdilnem nastavku	/ Priključne cevi niso popolnoma privijačene v osnovno ogrodje	/ Ročno zatisnite priključne cevi
	/ Obročna tesnila priključnih gibkih cevi so pokvarjena	/ Zamenjajte obročno tesnilo
/ Prenizka temperatura tople vode	/ Omejevalnik tople vode ni pravilno nastavljen	/ Nastavite omejevalnik tople vode

⚠ OHUTUSJUHISED

- ⚠ Kandke paigaldamisel muljumis- ja löikevigastuste vältimiseks kindaid.
- ⚠ Kui külma ja kuuma vee ühenduste surve on väga erinev, tuleb need tasakaalustada.

PAIGALDAMISJUHISED

- / Enne paigaldamist tuleb toodet kontrollida transpordikahjustuste osas. Pärast paigaldamist ei tunnustata enam transpordi- või pinnakahjustuste kaebuseid.
- / Voolikute ja segisti paigaldamisel, loputamisel ja kontrollimisel tuleb lähtuda kehtivatest normatiividest.
- / Vastavas riigis kehtivaid paigalduseeskirju tuleb järgida.

TEHNILISED ANDMED

Töörõhk
Soovitav töörõhk:
Kontrollsurve:

Kuuma vee temperatuur:
Soovitav kuuma vee temperatuur:
Terminline desinfektsioon:

Toode on ette nähtud eranditult joogivee jaoks!

maks. 1 MPa
0,1 - 0,5 MPa
1,6 MPa
(1 MPa = 10 baari = 147 PSI)
maks. 70°C
65°C
maks. 70°C/4 min

SÜMBOLITE KIRJELDUS



Ärge kasutage äädikhapet sisaldavat silikoonil



REGULEERIMINE (vt lk 33)

Sooja vee piirangu seadistamine. Ühenduses boileritega ei ole sooja vee blokeeringu soovitatav.



KASUTAMINE (vt lk 34)

/ Hansgrohe soovib mitte kasutada esimest poolt liitrit hommikuti või pärast pikemat seisakuaga joogiveena.

/ Väljavooluosa ei või keerata üle 360°, kuna see võib voolikut kahjustada.



PUHASTAMINE (vt lk 37)



HOOLDUS (vt lk 37)

Tagasilöögiklappide toimimist tuleb kooskõlas riiklike ja regionaalsete määrustega regulaarselt kontrollida vastavalt standardile DIN EN 1717 (vähemalt kord aastas).



MÕÕTUDE (vt lk 35)



LÄBIVOOLUDIAGRAMM (vt lk 35)

- ① tavajuga
- ② Duši juga



VARUOSAD (vt lk 36)

XXX = Värvid
000 = kroom
800 = roostevaba optik

SPETSIAALNE LISAVARUSTUS (ei sisaldu komplektis)



Hooldusvõti #95910000 (vt lk 36)



KONTROLLSERTIFIKAAT (vt lk 36)

RIKE	PÕHJUS	LAHENDUS
/ Segisti käib raskelt	/ Tööelement on katkine, lubjastunud	/ Vahetage tööelement
/ Segisti tilgub	/ Tööelement on katkine	/ Vahetage tööelement
/ Veeleke kinnituse juures	/ Ühendusvoolikud ei ole korralikult põhikorpuse külge kruvitud	/ Kruvige ühendusvoolikud käega kinni
	/ Ühendusvoolikute O-rõngastihendid katki	/ Vahetage O-rõngastihend
/ Sooja vee temperatuur liiga madal	/ Kuuma vee piirang valesti seatud	/ Seadke kuuma vee piirang

⚠ DROŠĪBAS NORĀDES

- ⚠ Montāžas laikā, lai izvairītos no saspiedumiem un iegriezumiem, nepieciešams nēsāt cimdus.
- ⚠ Jāizlīdzina spiediena atšķirības starp aukstā un karstā ūdens pievadiem.

NORĀDĪJUMI MONTĀŽAI

- / Pirms montāžas nepieciešams pārbaudīt, vai produktam transportēšanas laikā nav radušies bojājumi. Pēc iebūvēšanas bojājumi, kas radušies transportēšanas laikā, vai virsmas bojājumi netiek atzīti.
- / Cauruļvadi un armatūra ir jāuzstāda, jāizskalo un jāpārbauda saskaņā ar spēkā esošajiem standartiem.
- / Jāievēro attiecīgās valstīs spēkā esošās montāžas prasības.

TEHNISKIE DATI

Darba spiediens:
Ieteicamais darba spiediens:
Pārbaudes spiediens:

maks. 1 MPa
0,1 - 0,5 MPa
1,6 MPa
(1 MPa = 10 bar = 147 PSI)

Karstā ūdens temperatūra:
Ieteicamā karstā ūdens temperatūra:
Termiskā dezinfekcija :

maks. 70°C
65°C
maks. 70°C / 4 min

Izstrādājums ir paredzēts tikai dzeramajam ūdenim!

SIMBOLU NOZĪME

 Neizmantojot silikonu, kas satur etiķskābi!



I EREGULĒŠANA (skat. lpp. 33)

Karstā ūdens ierobežotāja regulēšana. Kopā ar caurteces sildītājiem nav ieteicams izmantot ūdens bloķētāju.



L IETOŠANA (skat. lpp. 34)

/ Hansgrohe iesaka no rīta vai pēc ilgākiem pārtraukumiem nelietot pirmo puslitru ūdens dzeršanai.

/ Snīpi negrieziet tālāk par 360°, jo tādējādi var tikt bojāta šļūtene.



T ĪRĪŠANA (skat. lpp. 37)



A P K O P E (skat. lpp. 37)

Regulāri jāpārbauda pretvārsta funkcija saskaņā ar DIN EN 1717 saistībā ar nacionālajiem vai vietējiem noteikumiem (vismaz vienreiz gadā).



I Z M Ē R U S (skat. lpp. 35)



C A U R P L Ū D E S D I A G R A M M A (skat. lpp. 35)

- ① Standarta strūkļa
- ② Dušas strūkļa



R E Z E R V E S D A Ļ A S (skat. lpp. 36)

XXX = Krāsu kodi
000 = hroma
800 = tērauda

S P E C I Ā L I A K S E S U Ā R I (komplektā netiek piegādāts)



Apkopes atslēga #95910000 (skat. lpp. 36)



P Ā R B A U D E S Z Ī M E (skat. lpp. 36)

TR AUCĒJUMS

- / Jaucējkrāns smagi grozāms
- / Jaucējkrāns piln
- / Ūdens noplūde pie nostiprinājuma
- / Pārāk zema ūdens temperatūra

I E M E S L S

- / Bojāta kartuša, aizkalļojusies
- / Bojāta kartuša
- / Pieslēguma šļūtenes nav līdz galam ieskrūvētas pamatelementā
- / Bojāti pieslēguma šļūtenju O-gredzeni
- / Nepareizi noregulāta karstā ūdens bloķēšana

B O J Ā J U M U N O V Ē R Š A N A

- / Nomainīt kartušu
- / Nomainīt kartušu
- / Pieslēguma šļūtenes ar roku pievilkt stingrāk
- / Nomainīt O-gredzenu
- / Noregulēt karstā ūdens ierobežošanu

⚠ SIGURNOSNE NAPOMENE

- ⚠ Prilikom montaže se radi sprečavanja prignječenja i posekotina moraju nositi rukavice.
- ⚠ Velika razlika u pritisku između vruće i hladne vode mora biti izbalansirana.

INSTRUKCIJE ZA MONTAŽU









- / Pre montaže se mora proveriti da li je proizvod oštećen pri transportu. Nakon ugradnje se ne priznaju nikakve reklamacije koje se odnose na površinska i transportna oštećenja.
- / Vodovi i armatura moraju biti postavljeni, isprani i testirani prema važećim normama.
- / Treba se pridržavati propisa koji u određenim zemljama važe za instalacije.

TEHNIČKI PODACI

Radni pritisak:	maks. 1 MPa
Preporučeni radni pritisak:	0,1 - 0,5 MPa
Probni pritisak:	1,6 MPa (1 MPa = 10 bar = 147 PSI)
Temperatura vruće vode:	maks. 70°C
Preporučena temperatura vruće vode:	65°C
Termička dezinfekcija:	maks. 70°C / 4 min

Proizvod je koncipiran isključivo za pijaću vodu!

OPIS SIMBOLA

-  Nemojte koristiti silikon koji sadrži sirćetnu kiselinu!
-  **PODEŠAVANJE** (vidi stranu 33)
Podešavanje ograničivača tople vode. U kombinaciji sa protočnim bojlerima ne preporučuje se primena sistema za blokiranje dotoka tople vode.
-  **RUKOVANJE** (vidi stranu 34)
/ Hansgrohe preporučuje da ujutru ili nakon dužeg nekorišćenja prvih pola litre vode ne koristite za piće.
/ Ispusno crevo se ne sme uvrtati više od 360°, jer bi se u protivnom moglo oštetiti.
-  **ČIŠĆENJE** (vidi stranu 37)
-  **ODRŽAVANJE** (vidi stranu 37)
Ispravno funkcionisanje nepovratnog ventila se mora redovno proveravati prema standardu DIN EN 1717 i u skladu s važećim nacionalnim ili regionalnim propisima (najmanje jednom godišnje).
-  **MERE** (vidi stranu 35)
-  **DIJAGRAM PROTOKA** (vidi stranu 35)
① Normalni mlaz
② mlaz
-  **REZERVNI DELOVI** (vidi stranu 36)
XXX = Oznake boja
000 = hrom
800 = dezen plemeniti čelik
- POSEBAN PRIBOR** (Nije sadržano u isporuci)
 Servisni ključ #95910000 (vidi stranu 36)
-  **ISPITNI ZNAK** (vidi stranu 36)

S METNJA	UZROK	POMOĆ
/ Ručica se zaglavila	/ Neispravna kartuša, nataloženi kamenac	/ Zamenite kartušu
/ Slavina kaplje	/ Neispravna kartuša	/ Zamenite kartušu
/ Voda izlazi na delu gde je slavina učvršćena	/ Priključna creva nisu potpuno učvršćena na telo / O prstenovi priključnih creva su neispravni	/ Priključna creva učvrstite rukom / Zamenite O prsten
/ Preniska temperatura tople vode	/ Ograničivač vruće vode nije dobro podešen	/ Podesite ograničivač vruće vode

⚠ SIKKERHETSHENVISNINGER

- ⚠ Bruk hansker under montasjen for å unngå klem- og kuttskader.
- ⚠ Store trykkdifferanser mellom kaldt- og varmtvannstilkoblinger skal utlignes.

MONTAGEHENVISNINGER

- / Før montasjen skal produktet sjekkes for transportskader. Etter monteringen aksepteres ikke noen transport- eller overflateskader.
- / Ledningene og armaturen skal monteres, spyles og sjekkes iht. de gyldige normer.
- / Gjeldende retningslinjer for rørleggerarbeid i de enkelte land skal følges.

TEKNISKE DATA

Driftstrykk	maks. 1 MPa
Anbefalt driftstrykk:	0,1 - 0,5 MPa
Prøvetrykk	1,6 MPa (1 MPa = 10 bar = 147 PSI)
Varmtvannstemperatur	maks. 70°C
Anbefalt temperatur for varmt vann	65°C
Termisk desinfisering:	maks. 70°C / 4 min

Produktet er utelukkende designet for drikkevann!

SYMBOLBESKRIVELSE

-  Ikke bruk silikon som inneholder eddiksyre!
-  **JUSTERING** (se side 33)
Innstilling av varmtvannsbegrensning. I forbindelse med gjennomstrømningsvarmere er det ikke anbefalt å bruke en varmtvannssperre.
-  **BETJENING** (se side 34)
/ Om morgen og etter lengre stagnasjonstider anbefaler Hansgrohe å ikke bruke den første halvliteren som drikkevann.
/ Ikke vri utløpet mer enn 360°, ellers blir slangen skadet.
-  **RENGJØRING** (se side 37)
-  **VEDLIKEHOLD** (se side 37)
Funksjonen til returløpssperren skal iht. DIN EN 1717 og i samsvar med de nasjonale og lokale forskrifter sjekkes regelmessig (minst en gang i året).
-  **MÅL** (se side 35)
-  **GJENNOMSTRØMNINGSDIAGRAM** (se side 35)
① Normalstråle
② Dusjstråle
-  **SERVICEDELER** (se side 36)
XXX = Fargekode
000 = krom
800 = rustfritt stål optikk
- EKSTRATILBEHØR** (ikke med i leveransen)
-  Servicenøkkel #95910000 (se side 36)
-  **PRØVEMERKE** (se side 36)

FEIL	ÅRSAK	FEILRETTELSE
/ Armatur ikke lett bevegelig	/ Kartusj defekt, forkalkning	/ Kartusj byttes
/ Armatur drypper	/ Kartusj defekt	/ Kartusj byttes
/ Vannlekkasje på festeskift	/ Tilkoblingsslanger ikke skrudd helt inn i basiselement	/ Tilkoblingsslanger trekkes fast fra hånd
	/ O-ring på tilkoblingsslangen defekt	/ O-ring byttes
/ For lav varmtvannstemperatur	/ Varmtvannsbegrensning er feil innstilt	/ Varmtvannsbegrensning innstilles

⚠ УКАЗАНИЯ ЗА БЕЗОПАСНОСТ

- ⚠ При монтажа трябва да се носят ръкавици, за да се избегнат наранявания поради притискане или порязване.
- ⚠ Големите разлики в налягането между изводите за студената и топлата вода трябва да се изравняват.

УКАЗАНИЯ ЗА МОНТАЖ









- / Преди монтажа продуктът трябва да се провери за транспортни щети. След монтажа не се признават транспортни или повърхностни щети.
- / Тръбопроводите и арматурата трябва да се монтират, промият и проверят в съответствие с валидните норми.
- / Трябва да бъдат спазвани валидните в съответните страни предписания за инсталиране.

ТЕХНИЧЕСКИ ДАННИ

Работно налягане:	макс. 1 МПа
Препоръчително работно налягане:	0,1 - 0,5 МПа
Контролно налягане:	1,6 МПа (1 МПа = 10 bar = 147 PSI)
Температура на горещата вода:	макс. 70°C
Препоръчителна температура на горещата вода:	65°C
Термична дезинфекция:	макс. 70°C/4 мин

Продуктът е разработен само за питейна вода!

ОПИСАНИЕ НА СИМВОЛИТЕ

-  Не използвайте силикон, съдържащ оцетна киселина!
-  ЮСТИРАНЕ (вижте стр. 33)
Настройка на ограничителя за топлата вода. Във връзка с проточни нагреватели не се препоръчва блокировка за топлата вода
-  ОБСЛУЖВАНЕ (вижте стр. 34)
/ Hansgrohe препоръчва, сутрин и след по-продължително спиране първият половин литър да не се използва като питейна вода.
/ Не завъртайте изпускателния отвор на повече от 360°, тъй като в противен случай може да се повреди маркучът.
-  ПОЧИСТВАНЕ (вижте стр. 37)
-  ПОДДРЪЖКА (вижте стр. 37)
Съгласно DIN EN 1717 функционирането на приспособленията за предотвратяване на обратния поток трябва редовно да се проверява в съответствие с националните или регионални изисквания (поне веднъж годишно).
-  РАЗМЕРИ (вижте стр. 35)
-  ДИАГРАМА НА ПОТОКА (вижте стр. 35)
① Нормална струя
② Разпръскваща струя
-  СЕРВИЗНИ ЧАСТИ (вижте стр. 36)
XXX = Цветово кодиране
000 = хром
800 = оптика на благородна стомана
- СПЕЦИАЛНИ ПРИНАДЛЕЖНОСТИ (не се съдържа в обема на доставка)
 Сервизен ключ #95910000 (вижте стр. 36)
-  КОНТРОЛЕН ЗНАК (вижте стр. 36)

НЕИЗПРАВНОСТ	ПРИЧИНА	ПОМОЩ
/ Трудно подвижна арматура	/ Дефектна гилза, покрита с варовик	/ Сменете гилзата
/ Арматурата капе	/ Дефектна гилза	/ Сменете гилзата
/ Избиване на вода от закрепващата шийка	/ Съвързващите маркучи не са напълно завинтени в основното тяло	/ Затегнете на ръка съвързващите маркучи
	/ Дефектен О-образен пръстен на съвързващия маркуч	/ Смяна на О-образен пръстен
/ Твърде ниска температура на водата	/ Ограничението за топлата вода е грушно настроено	/ Настройте ограничението за топлата вода

⚠ UDHËZIME SIGURIE

- ⚠ Për të evituar lëndimet e pickimeve ose të prerjeve gjatë procesit të montimit duhet që të vishni doreza.
- ⚠ Ndryshimet e mëdha të presionit mes lidhjeve të ujit të ftohtë dhe atij të ngrohtë duhen ekuilibruar.

UDHËZIME PËR MONTIMIN

- / Përpara montimit duhet që produkti të kontrollohet për dëmtime nga transporti. Pas instalimit nuk do të njihet asnjë dëmtim nga transporti ose dëmtim i sipërfaqes.
- / Tubacionet dhe rubinetet duhet që të montohen, të shpëlahen dhe të kontrollohen sipas standardeve në fuqi
- / Duhet të respektohen linjat udhëzuese të instalimit, të vlefshme për vendet respektive.

TË DHËNA TEKNIKE

Presioni gjatë punës

Presioni i rekomanduar:

Presioni për provë:

Temperatura e ujit të ngrohtë

Temperatura e rekomanduar e ujit të ngrohtë:

Dezinfektim Termik:

Produkti është projektuar ekskluzivisht për ujë të pijshëm!

maks. 1 MPa

0,1 - 0,5 MPa

1,6 MPa

(1 MPa = 10 bar = 147 PSI)

maks. 70°C

65°C

maks. 70°C/4 min

PËRSHKRIMI I SIMBOLIT



Mos përdorni silikon që në përbërje ka acid acetik.



J U S T I M I (shih faqen 33)

Rregullimi i kufizimit me ujë të nxehtë. Nje kombinim me një bojler ujit nuk është i rekomanduar.



P Ë R D O R I M I (shih faqen 34)

/ Hansgrohe rekomandon që në mëngjes ose pas periudhave të gjata që gjysmë litri i parë mos të pihet

/ Dalja nuk duhet rrotulluar më shumë se 360°, sepse mund të dëmtohet tubi.



P A S T R I M I (shih faqen 37)



M I R Ë M B A J T J A (shih faqen 37)

Penguesit e rrjedhjes në drejtim të kundërt duhen kontrolluar rregullisht në bazë të normave DIN EN 1717 konform normave nacionale dhe regjionale (së paku një herë në vit).



P Ë R M A S A T (shih faqen 35)



D I A G R A M I I Q A R K U L L I M I T (shih faqen 35)

① Curril normal

② currila/trezja sperkatose



P J E S Ë T E S E R V I S I T (shih faqen 36)

XXX = Kodimi me anë të ngjyrave

000 = krom

800 = optikë çeliku

P A J I S J E T Ë P O S A Ç M E (nuk përfshihet në vëllimin e furnizimit)



Çelësi i servisit #95910000 (shih faqen 36)



S H E N J A E K O N T R O L L I T (shih faqen 36)

D E M T I M	S H K A K U	N D I H M E
/ Armatura punon rende	/ Kartusha me defekt, me kalk	/ Kembeni kartushen
/ Armatura pikon	/ Kartusha me defekt	/ Kembeni kartushen
/ Dalje e ujit ne cilindrin fiksues	/ Tubat e lidhjes jo komplet te vidhosur ne karkasen baze	/ Shtrengojini manualisht tubat e lidhur
	/ Unaza O tek tubi lidhes me defekt	/ Kembeni unazen O
/ Temperaturë e ulët e ujit të ngrohtë	/ Kufiri i ujit te ngrohte eshte regjistruar gabim	/ Regjistroni kufirin e ujit te ngrohte

وصف الرمز

هام! لا تستخدم السليكون الذي يحتوي على أحماض!



الضبط (راجع صفحة 33)



ضبط تحديد المياه الدافئة. لا ينصح باستخدام محدد المياه الدافئة مع سخان المياه الوتقي.

التشغيل (راجع صفحة 34)



/ تنصح شركة هانزجروهي Hansgrohe بعدم استخدام أول نصف لتر من الماء لغرض الشرب وذلك في الصباح أو بعد توقف استخدام الماء لفترات طويلة نسبياً.

/ لا تقم بتدوير الصنبور أكثر من 360 درجة، وإلا تسبب ذلك في تلف الخرطوم.

التنظيف (راجع صفحة 37)



يجب فحص صمام عدم الرجوع بصفة منتظمة حسب المواصفة DIN EN 1717 وذلك طبقاً للوائح الوطنية أو الإقليمية (مرة واحد سنوياً على الأقل).

الصيانة (راجع صفحة 37)



الحد الأقصى 1 ميجاباسكال

0,5 – 0,1 ميجاباسكال

1,6 ميجاباسكال

(1 ميجاباسكال = 10 بار = 147 PSI)

الحد الأقصى 70°C

65°C

الحد الأقصى 4/70°C الدقيقة

تنبيهات الأمان

△ يجب إرتداء قفازات لليد أثناء التركيب لتجنب حدوث أخطار الإنحشار أو الجروح.

△ يجب أن يكون تيار الماء الساخن والماء البارد متعادلين في الضغط.

تعليمات التركيب

/ قبل القيام بعملية التركيب، يجب فحص المنتج للتأكد من خلوه من أية تلفيات ناتجة عن النقل. بعد القيام بعملية التركيب، لن يتم الاعتراف بوجود أية تلفيات سطحية أو تلفيات ناتجة عن عملية النقل.

/ يجب تركيب وغسيل واختبار التوصيلات وخلطات المياه طبقاً للمعايير السارية.

/ يجب مراعاة القواعد الخاصة بالتركيب وأعمال السباكة وفقاً للوائح الخاصة بكل بلد.

المواصفات الفنية

ضغط التشغيل:

ضغط التشغيل الموصى به:

ضغط الاختبار:

درجة حرارة الماء الساخن:

درجة الحرارة الموصى بها للماء الساخن:

تعقيم حراري:

المنتج مخصص فقط لماء الشرب!

أبعاد (راجع صفحة 35)



رسم للصرف (راجع صفحة 35)



① رشاش عادي
② الدش

قطع الغيار (راجع صفحة 36)



XXX = الألوان

000 = كروم

800 = مظهر الإستنليس ستيل

ملحقات خاصة (غير مدرج مع المحتويات المسلمة)

مفتاح الخدمة #95910000 (راجع صفحة 36)



شهادة اختبار (راجع صفحة 36)



العطل	السبب	العلاج والإصلاح
/ الخلاط ثقيل الحركة	/ الخرطوشة تالفة، تراكم عليها الجير	/ قم بتغيير الخرطوشة
/ تساقط قطرات مياه من الخلاط	/ الخرطوشة تالفة	/ قم بتغيير الخرطوشة
/ خروج الماء من جزء التثبيت	/ خراطيم التوصيل ليست مربوطة في الجزء الرئيسي بشكل كامل	/ اربط خراطيم التوصيل بيدك
/ درجة حرارة الماء الساخن منخفضة للغاية	/ الحلقة الدائرية الخاصة بخرطوم التوصيل تالفة	/ قم بتغيير الحلقة الدائرية
	/ محدد الماء الساخن مضبوط بشكل خاطيء	/ قم بضبط محدد الماء الساخن



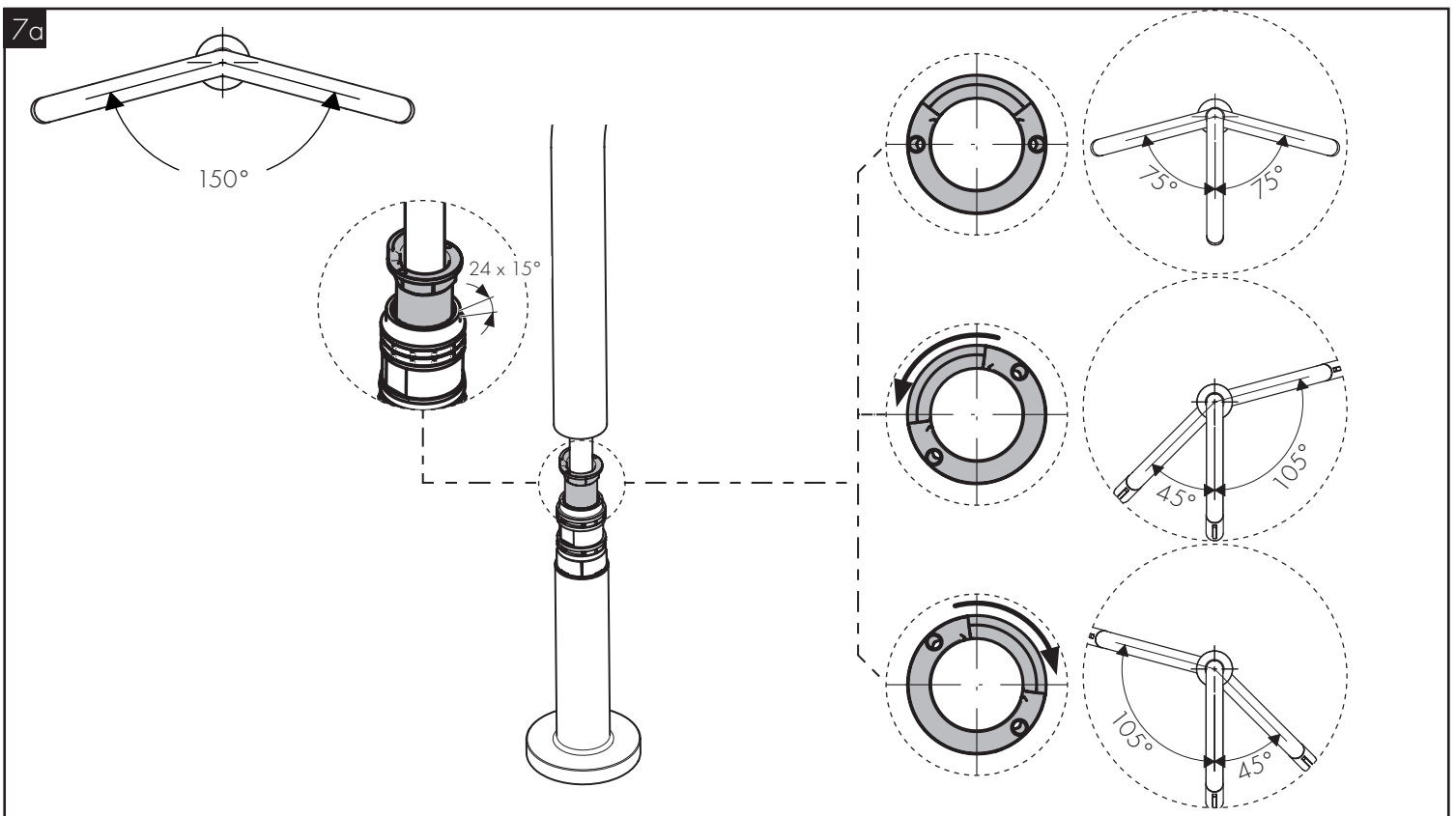
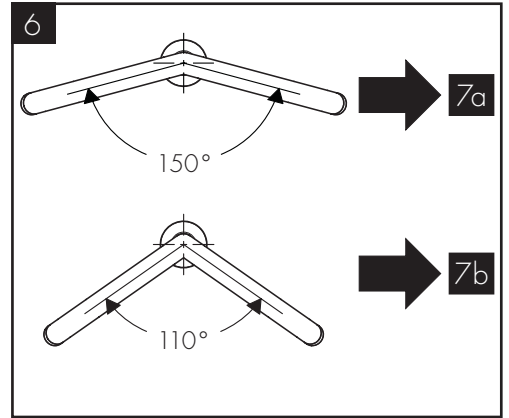
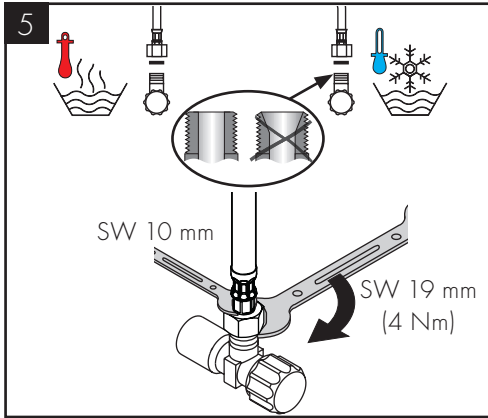
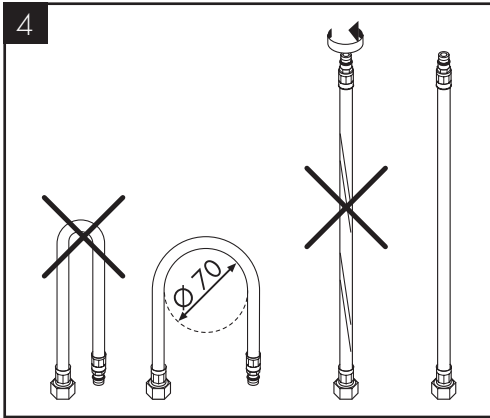
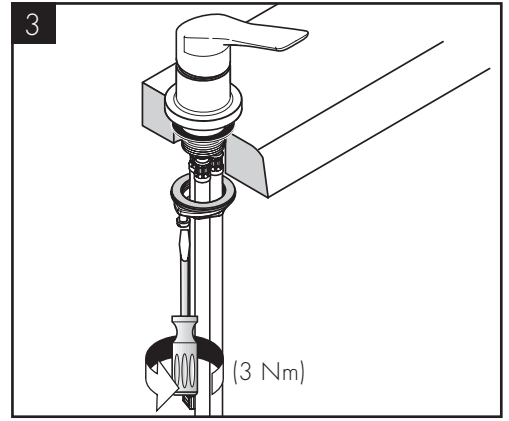
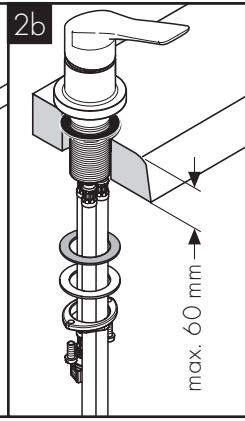
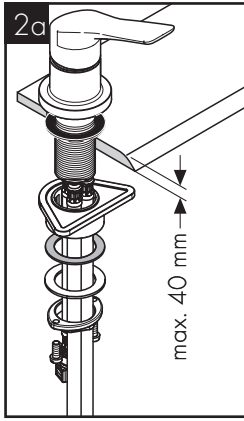
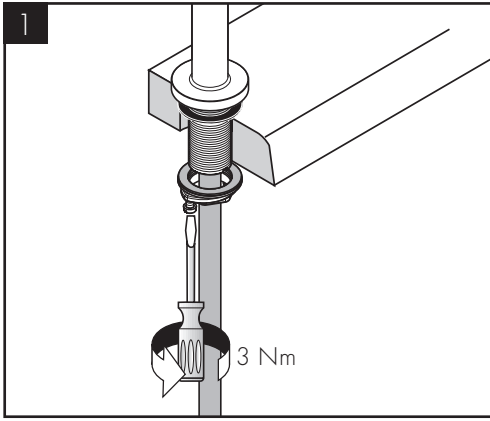

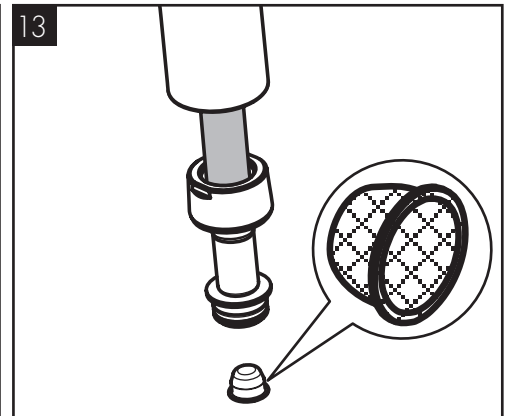
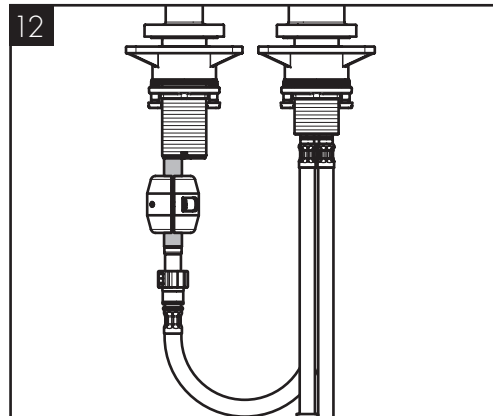
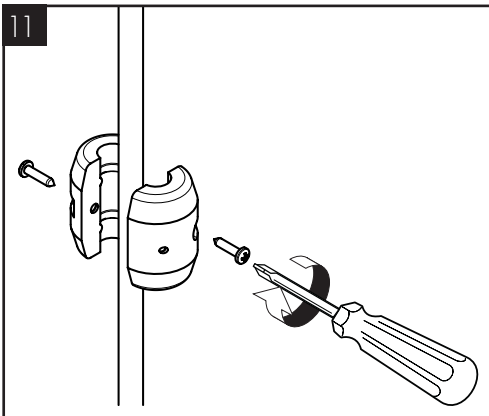
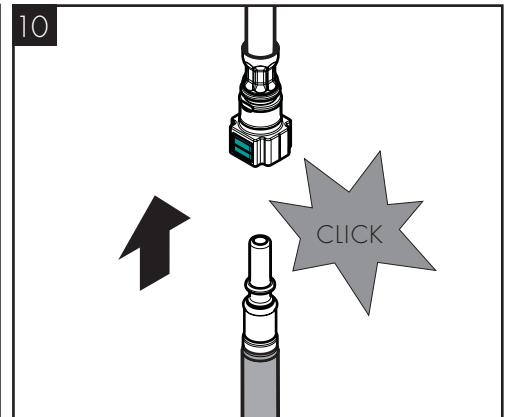
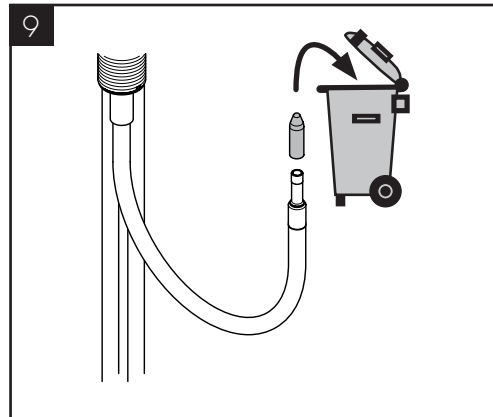
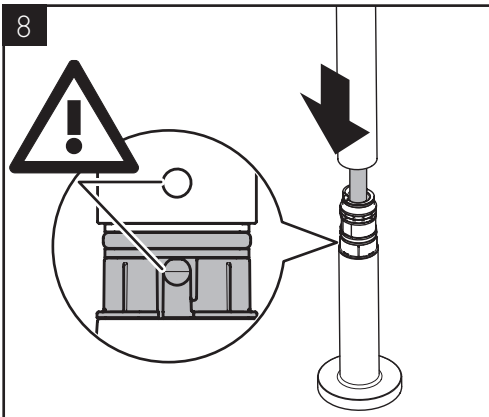
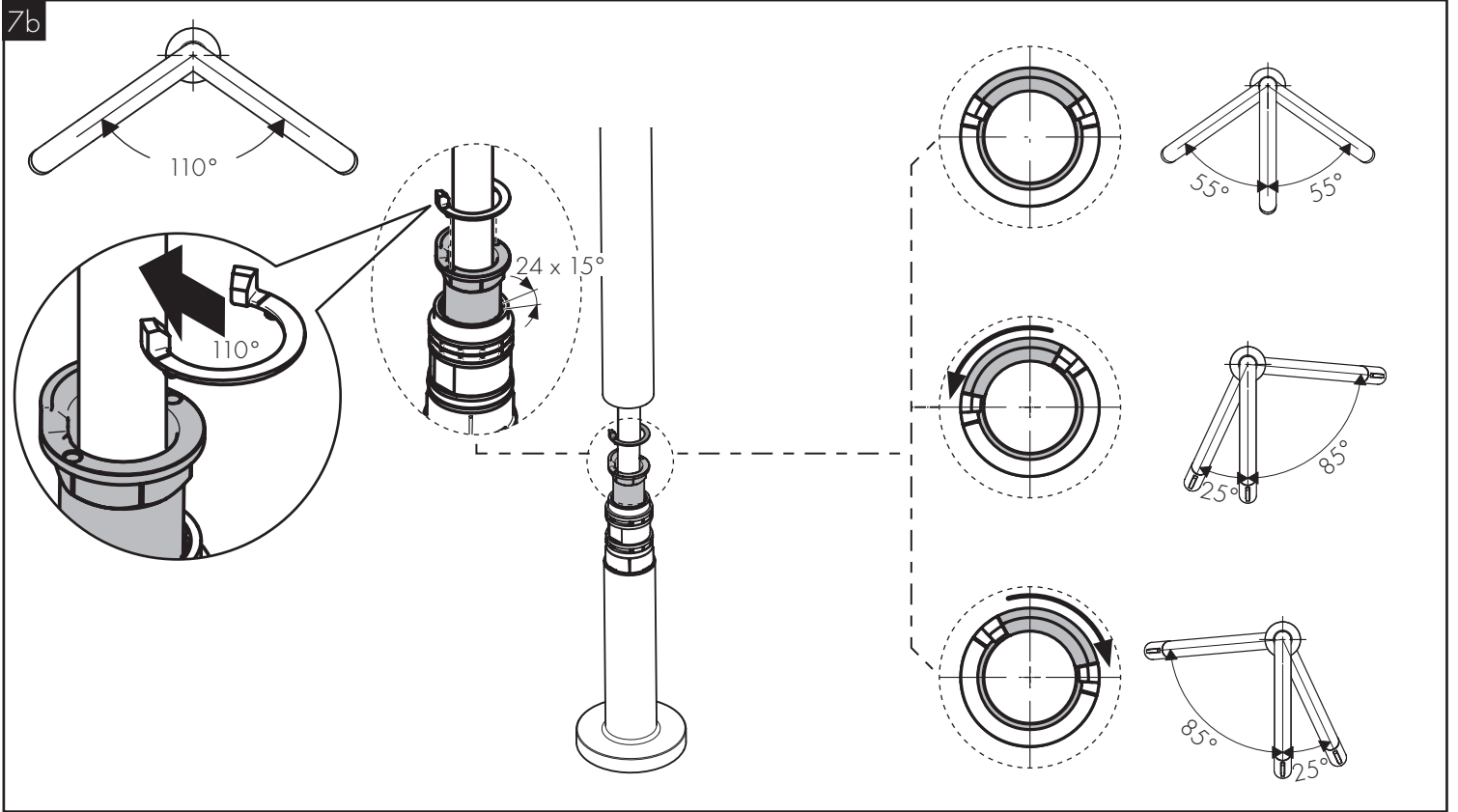

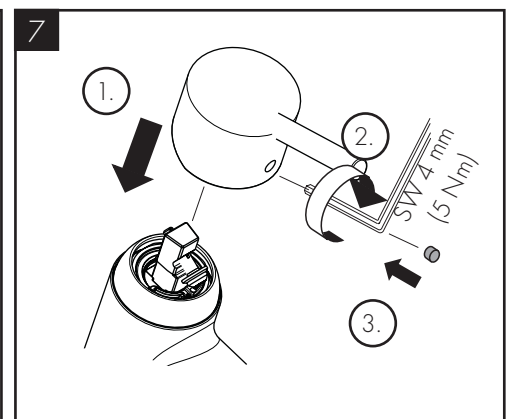
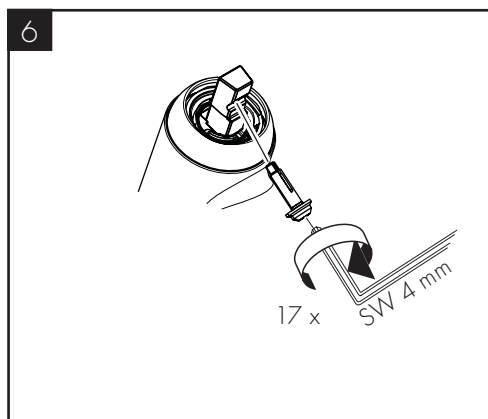
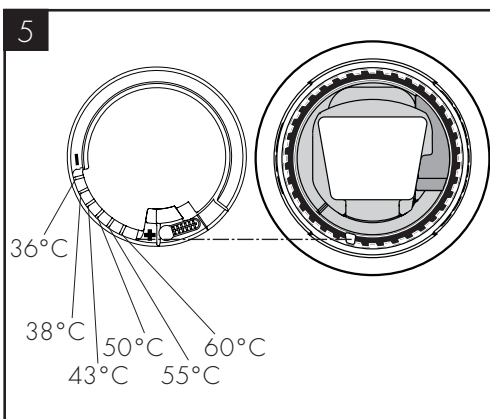
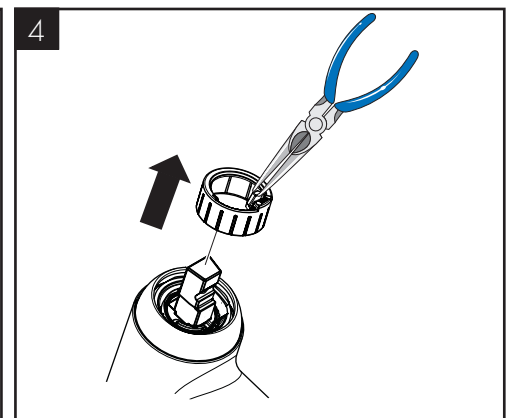
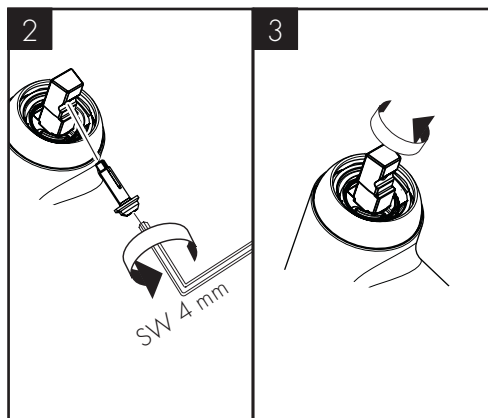
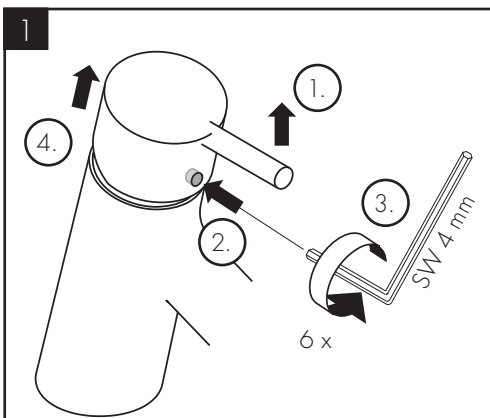
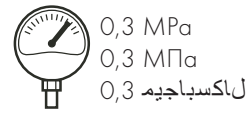
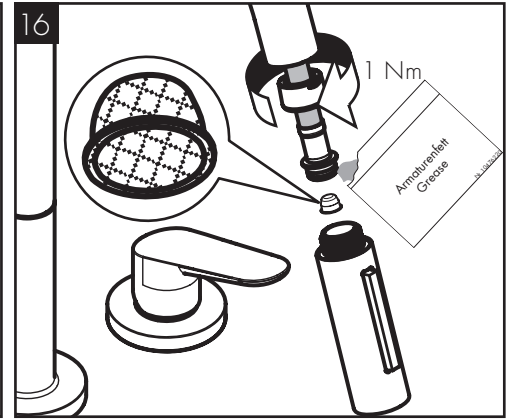
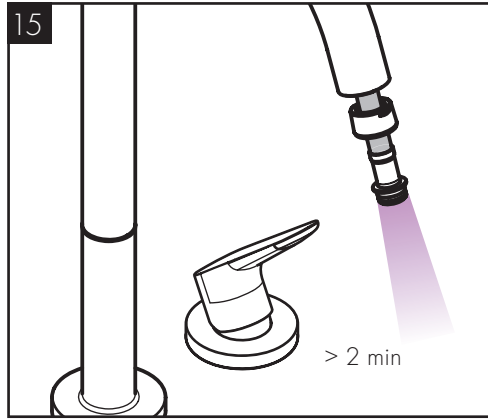
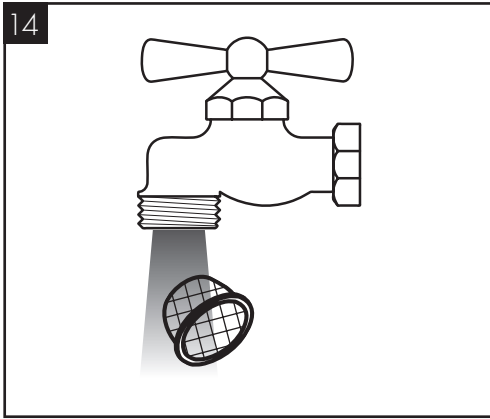

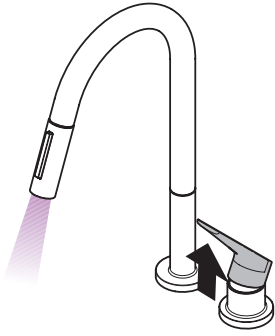

öföfnen / ouvert / open / aperto / abierto / open / åbne / abrir / otworzyć / otevřít / otvorit / 开 / открьт / nyitás / avaaaminen / öppna / atidaryti / Otvra ranje / açmak / deschide / ανοικτό / odpreti / avage / atvērt / otvoriti / árne / отваряне / hare / فتح

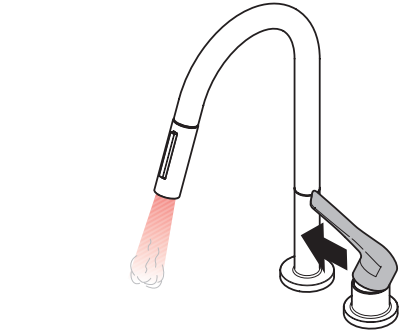
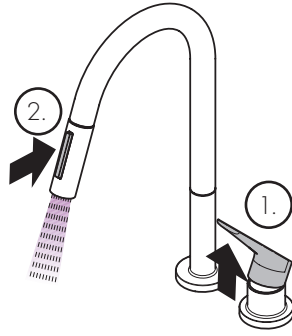

warm / chaud / hot / caldo / caliente / warm / varmt / quente / ciepła / teplá / teplá / 热 / горячая / meleg / lämmin / varmt / karštas / Vruća voda / sıcak / cald / ζεστό / toplo / kuum / karsts / topla / varm / топло / i ngrohtë / ساخن

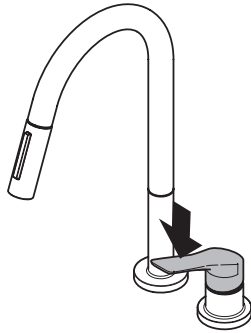

schließen / fermé / close / chiudere / cerrar / sluiten / lukke / fechar / zamknąć / zavřít / uzavrieť / 关 / закрыть / bezárás / sulkeminen / stänga / uždaryti / Zatvaranje / kapatmak / închide / κλειστό / zapreti / sulgege / aizvērt / zatvori / lukke / затваряне / mbylle / إغلاق

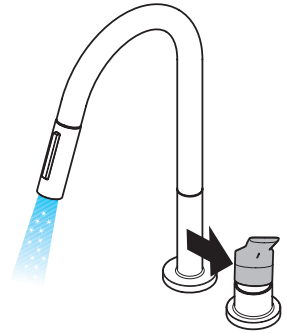

kalt / froid / cold / freddo / frío / koud / koldt / fría / zimna / studená / studená / 冷 / холодная / hideg / kylmä / kallt / šaltas / Hladno / soğuk / rece / κρύο / mrzlo / külm / auksts / hladno / kaldt / студено / i ftohtë / بارد



AXOR Citterio M
34822000 / 34822800

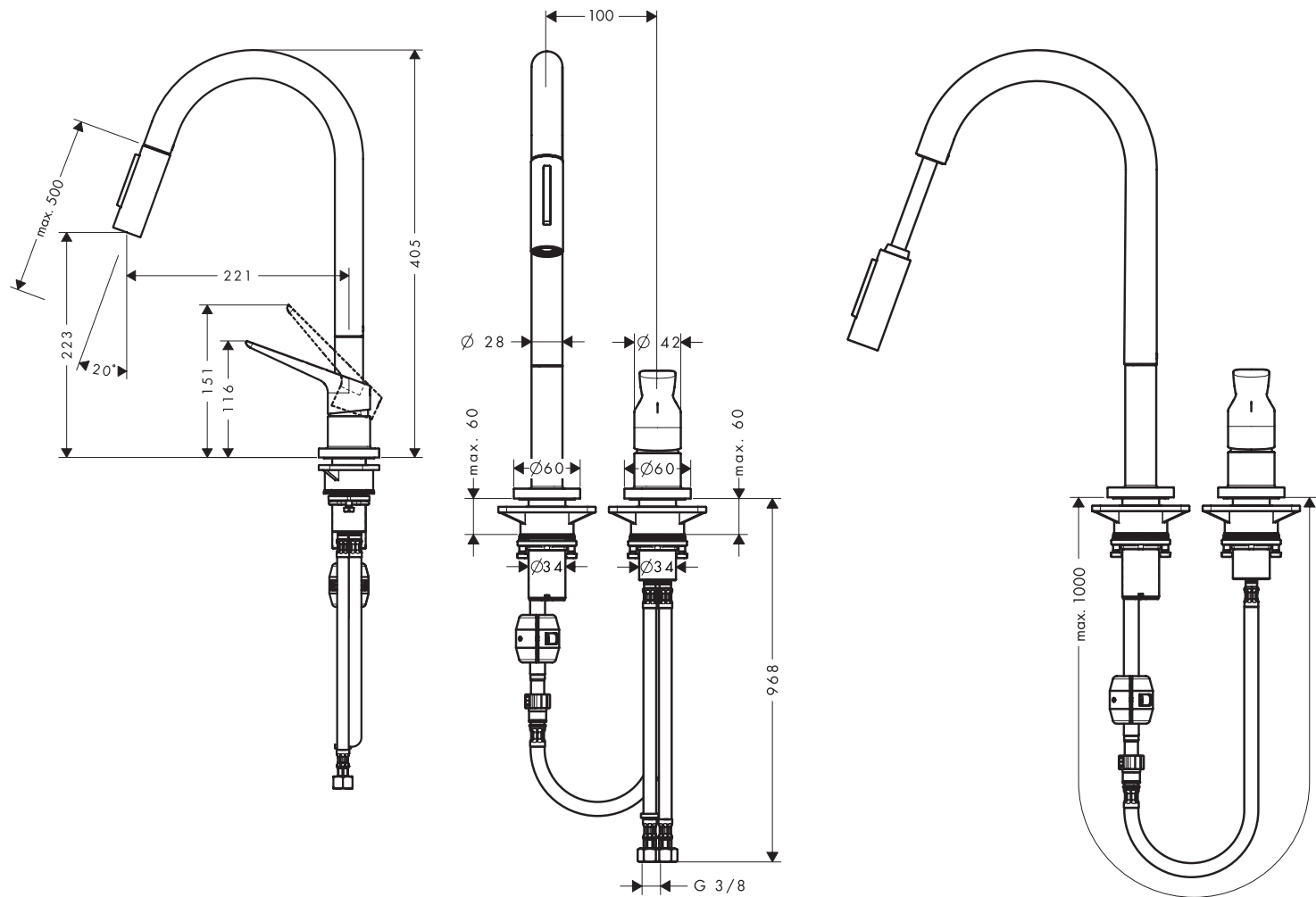

AXOR Citterio M
34822000 / 34822800

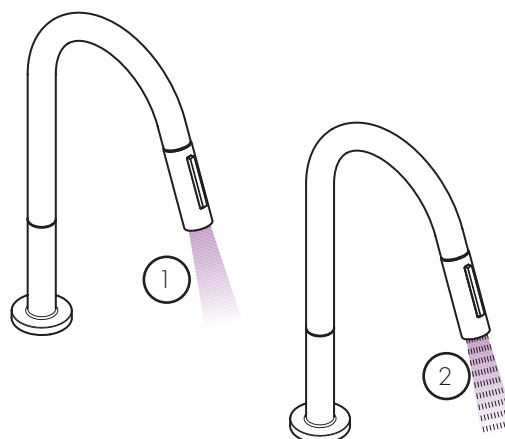
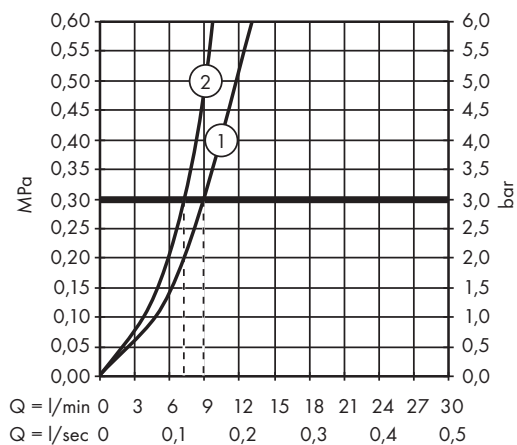

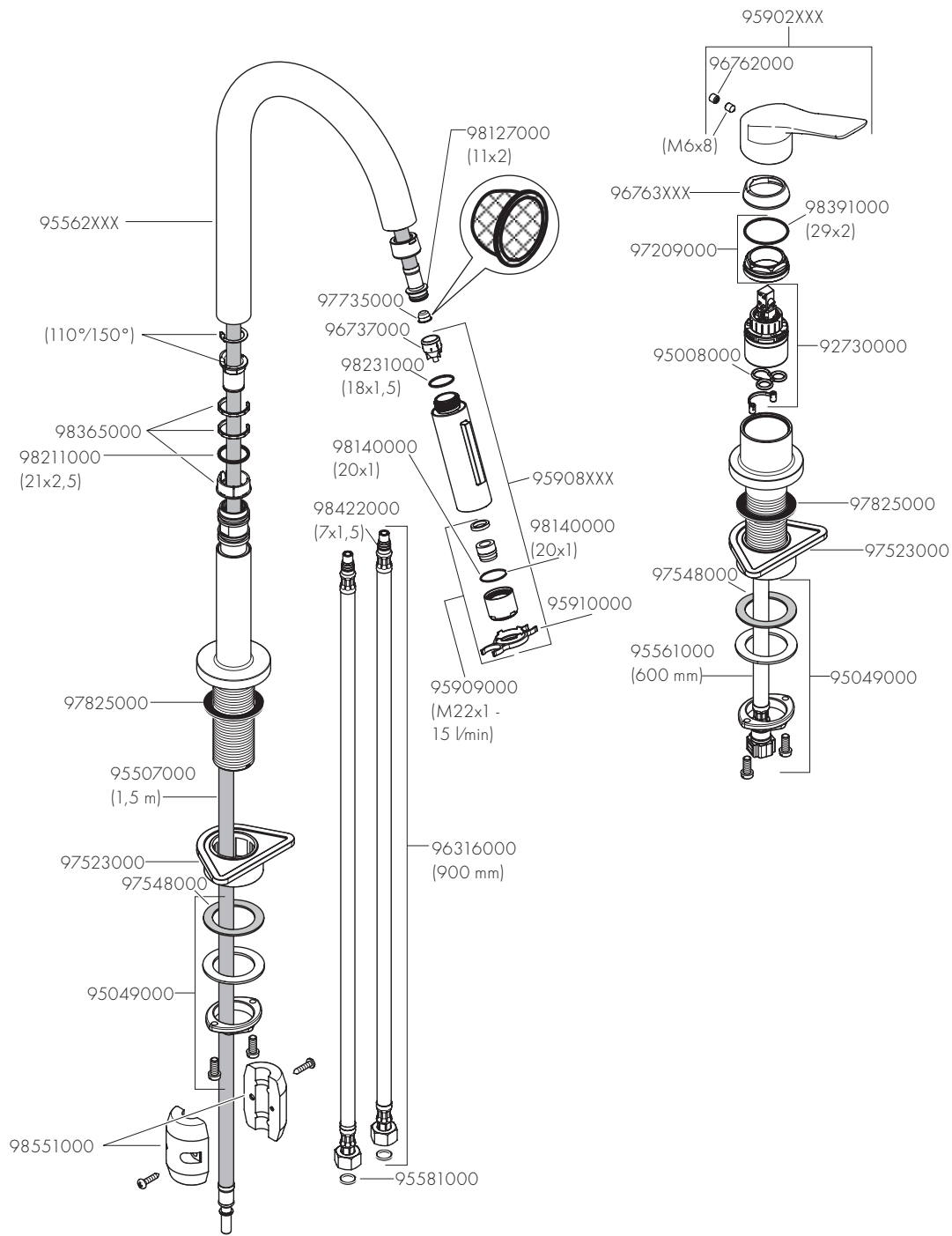

P-IX

DVGW

SVGW

WRAS

KIWA

NF

ACS

ETA



34822XXX

P-IX 19705/10

X

va 1.42/20146

1432





DE / Reinigungsempfehlung/Garantie/Kontakt
 FR / Recommandation pour le nettoyage/Garanties/Contact
 EN / Cleaning recommendation/Warranty/Contact
 IT / Raccomandazione di pulizia/Garanzia/Contatto
 ES / Recomendaciones para la limpieza/Garantía/Contacto
 NL / Aanbevelingen inzake reiniging/Garantie/Contact
 DK / Rensning, anbefaling/Garanti/Kontakt
 PT / Recomendações de limpeza/Garantia/Contacto
 PL / Zalecenie dotyczące pielęgnacji/Gwarancja/Kontakt
 CS / Doporučení k čištění/Záruka /Kontakt
 SK / Odporúčania pre čistenie/Záruka/Kontakt
 ZH / 清洁指南 / 担保 / 接触
 RU / Рекомендации по очистке/Гарантия/Контакты
 HU / Tisztítási tanácsok/Garancia/érintkezés
 FI / Puhdistussuositus/Takuu/Kosketus
 SV / Rengöringsrekommendationer/Garanti/Contacto
 LT / Valymo rekomendacijos/Garantija/Kontaktai
 HR / Preporuke za čišćenje/Garancija/Kontakt
 TR / Temizleme önerisi/Garanti/Temas
 RO / Recomandări pentru curățare/Garanție/Contact
 EL / Σύσταση καθαρισμού/Εγγύηση/επαφή
 SL / Priporočilo za čiščenje/Garancija/Kontakt
 ET / Puhastussoovitused/Garantii/Kontakt
 LV / Tīrīšanas ieteikumi/Garantija/Kontakti
 SR / Preporuke za čišćenje/Garancija/Kontakt
 NO / Anbefaling for rengjøring/Garanti/Kontakt
 BG / Препоръка за почистване/Гаранция/Контакт
 SQ / Këshilla rreth pastrimit/Garancia/Kontakt
 KO / 세정시 권장사항/품질보증/접촉
 AR / توصيات التنظيف/الضمان (الولايات المتحدة الأمريكية)/اتصال



[www.axor-design.com/
cleaning-recommendation](http://www.axor-design.com/cleaning-recommendation)

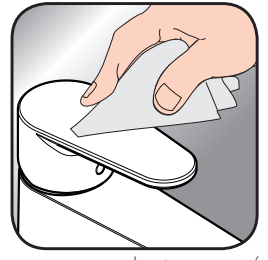

[www.axor-design.com/
cleaning-recommendation](http://www.axor-design.com/cleaning-recommendation)



[www.axor-design.com/
cleaning-recommendation](http://www.axor-design.com/cleaning-recommendation)



[www.axor-design.com/
cleaning-recommendation](http://www.axor-design.com/cleaning-recommendation)

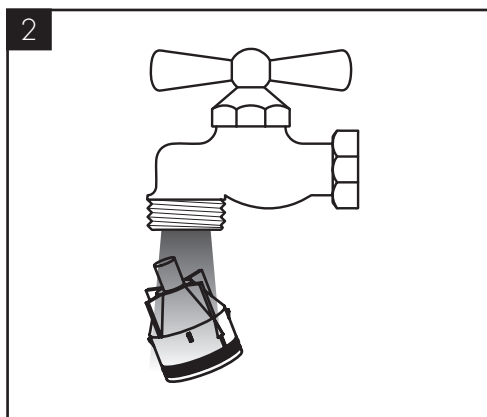
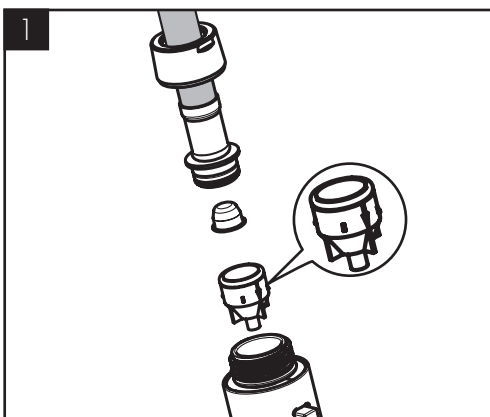
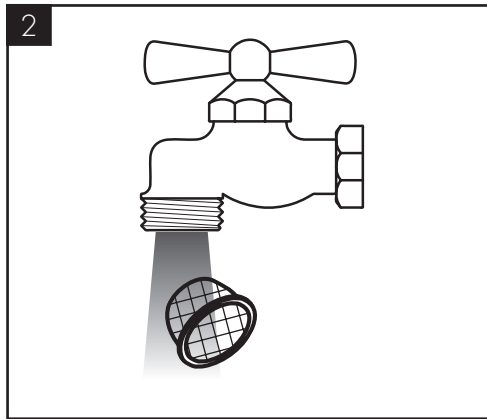
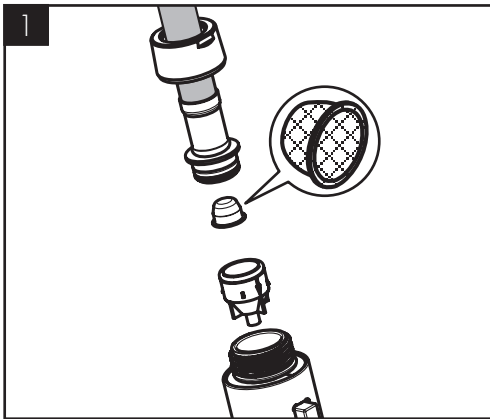

AXOR

AXOR / Hansgrohe SE
Austraße 5-9
77761 Schiltach
Deutschland

info@axor-design.com
axor-design.com

06/2018
9.01799.06